

Zaffar Zafar

 **Mariani**

office

▶ INDICE
INDEX

 **Mariani**

11 L'UFFICIO CONTEMPORANEO
13 UFFICI DIREZIONALI
225 TAVOLI RIUNIONE
263 POLTRONE PER UFFICIO
291 DIVANI E POLTRONE

11 THE CONTEMPORARY OFFICE
13 EXECUTIVE OFFICES
225 CONFERENCE TABLES
263 OFFICE ARMCHAIRS
291 SOFAS AND ARMCHAIRS

▶ UFFICI DIREZIONALI
EXECUTIVE OFFICES

14 CARTESIANO



32 EUCLIDEO



42 KEFA



64 AVATAR



88 CROSSING



102 DE SYMETRIA



130 BLADE



150 PASO DOBLE



170 ARES



184 DOLMEN



196 METEORA



214 ELITE

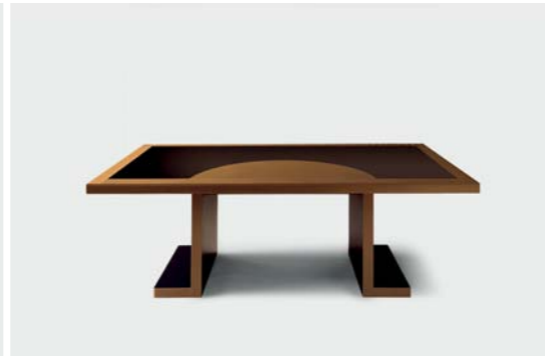

▶ TAVOLI RIUNIONE
CONFERENCE TABLES

226 MASTER



232 LEADER



238 PRESIDENT



248 PAPIER



254 BIG



► POLTRONE PER UFFICIO
OFFICE ARMCHAIRS

264 GARBO



266 KEFA



267 SILHOUETTE



268 WING



270 BLADE



271 SHU



271 VOILE



272 ARES



273 GINZA



274 LUX



275 LOOP



276 CASSANDRA



277 BIG



278 OPHY



279 TUCROMA



▶ DIVANI E POLTRONE
SOFAS AND ARMCHAIRS

292 LOUNGE



293 SAVILE ROW



294 BLOB



295 WOODY



296 PIGRECO



297 QUEBEC



298 CHESTERMAN



299 KUBICO



300 NIKITA



office

 **Mariani**

► L'UFFICIO CONTEMPORANEO

Pensiamo e produciamo uffici prestigiosi, per noi non sono solo spazi di lavoro ma ambienti con una forte valenza rappresentativa, dove lo status di chi vi opera non è dato dall'ostentazione ma dalla percepibile qualità intrinseca del progetto e dalle soluzioni formali ed ergonomiche.

Le piacevoli sensazioni trasmesse dal mix di materiali preziosi: essenze, pelli, marmi e cristallo sono rese possibili da una inappuntabile qualità esecutiva, raggiungibile solo attraverso il sottile equilibrio tra i processi industriali e l'inimitabile manualità dell'artigiano.

► THE CONTEMPORARY OFFICE

We think and produce prestigious offices, for us they are not just work spaces but environments with a strong representative value, where the status of those who work there, is not given by ostentation but by the perceptible intrinsic quality of the project and formal and ergonomic solutions.

The pleasant sensations conveyed by the mix of precious materials: essences, leathers, marbles and glass are made possible by an impeccable executive quality, reachable only through the fine balance between industrial processes and the inimitable craftsmanship.

office |

▶ UFFICI DIREZIONALI
EXECUTIVE OFFICES

 **Mariani**

14	CARTESIANO
32	EUCLIDEO
42	KEFA
64	AVATAR
88	CROSSING
102	DE SYMETRIA
130	BLADE
150	PASO DOBLE
170	ARES
184	DOLMEN
196	METEORA
214	ELITE



▶ **CARTESIANO**
DESIGN: FERRUCCIO LAVIANI



Finiture: ebano macassar e cuoio CV Holiday H31. Poltrone ufficio in pelle PA Van Gogh.
Finishings: macassar ebony wood and saddle leather CV Holiday H31. Office armchairs in leather PA Van Gogh.







Finiture: noce canaletto fiammato tinto grigio, pelle PX Grease e marmo Saint-Laurent.
Finishings: veined black walnut wood grey stained, leather PX Grease and marble Saint-Laurent.





CARTESIANO

DESIGN: FERRUCCIO LAVIANI

Il modello è disponibile in diverse dimensioni e finiture che utilizzano i seguenti materiali principali: pelle, cuoio, essenza di noce canaletto tinto grigio ed essenza di ebano macassar. Altre finiture disponibili solo su richiesta.

I piani e le gambe delle scrivanie sono realizzati in pannello di particelle di legno impiallacciate o rivestiti in cuoio o pelle. I piani delle scrivanie sono dotate di serie di una scatola elettrificata con 2x prese di corrente universali, 2x USB, 1x Audio 3.5, 1x HDMI, 2x RJ45 con tappo di copertura rivestito in cuoio o pelle.

La scrivania è sempre dotata di una gamba e di un elemento frontale che fuoriesce dal piano di lavoro, il quale è disponibile rivestito in cuoio o pelle, in essenza oppure in marmo New Saint Laurent. La scrivania per motivi di stabilità, necessita di un mobile cassetiera o di un mobile allungo fissi. La cassetiera fissa ha una struttura in essenza; l'allungo ha sempre la base, i piedini ed il fianco in essenza mentre il top può essere rivestito in cuoio o pelle oppure in essenza. Sia per cassetiera che per allungo, i frontali sono costituiti da pannelli, ante o cassetti disponibili nelle medesime finiture; il meccanismo di apertura è sempre con sistema push & pull. Sui frontali sono disponibili delle maniglie o in cuoio o in acciaio verniciato color peltro.

I mobili sono disponibili in due altezze (760 mm o 960 mm). Le strutture dei mobili sono realizzate sempre in nobilitato nero spessore 19 mm. La base, i piedini ed il fianco destro sono sempre in essenza; il top ed il fianco sinistro sono disponibili in cuoio o pelle e in essenza. I frontali dei mobili sono costituiti da cassetti ed ante di varie dimensioni e sono disponibili in cuoio o pelle o in essenza. Le maniglie sono sempre in cuoio o pelle o in acciaio verniciato color peltro. I ripiani interni sono sempre realizzati in nobilitato nero mentre i cassetti sono in pannello multistrato di faggio laccati nero opaco con delle guide in acciaio.

The model is available in different dimensions and finishes with the following main materials: leather, saddle leather, gray stained black walnut wood and macassar ebony wood. Other finishes available only on request.

The tops and legs of the desks are made of particleboard panel veneered or covered with leather or saddle leather. The top of desks are equipped with an electrified box with 2x universal power outlets, 2x USB, 1x Audio 3.5, 1x HDMI, 2x RJ45 with a leather or saddle leather cover cap.

The desk is always equipped with a leg and a front element that comes out from the top, which is available upholstered in leather or saddle leather, veneered or in New Saint Laurent marble. For reasons of stability, the desk requires a chest of drawers or a fixed return cabinet. The fixed chest of drawers has a veneered frame; the return cabinet always has the base, the feet and the side veneered while the top can be covered in leather or saddle leather or veneered. In both cases the doors or drawers are available in the same finishes; the opening mechanism is always with a push & pull system. Handles are available in pewter-colored leather or steel.

The furniture is available in two heights (760 mm or 960 mm). The furniture structures are always made of 19 mm thick black melamine. The base, the feet and the right side are always in essence; the top and left side are available in leather or leather and in essence. The fronts of the furniture consist of drawers and doors of various sizes and are available in leather or leather or in essence. The handles are always in leather or leather or in pewter-colored steel. The internal shelves are always made of black melamine while the drawers are in matt black beech plywood with steel guides.



SCRIVANIE / DESKS



L/W 220 cm - A/H 73 cm - P/D 110 cm
L/W 86"5/8 - A/H 28"3/4 - P/D 43"1/4

CARTESD1800CU



L/W 240 cm - A/H 73 cm - P/D 110 cm
L/W 94"1/2 - A/H 28"3/4 - P/D 43"1/4

CARTESD1801CU



L/W 260 cm - A/H 73 cm - P/D 110 cm
L/W 102"3/8 - A/H 28"3/4 - P/D 43"1/4

CARTESD1802CU



L/W 220 cm - A/H 73 cm - P/D 110 cm
L/W 86"5/8 - A/H 28"3/4 - P/D 43"1/4

CARTESD1800NG
CARTESD1800EM



L/W 240 cm - A/H 73 cm - P/D 110 cm
L/W 94"1/2 - A/H 28"3/4 - P/D 43"1/4

CARTESD1801NG
CARTESD1801EM



L/W 260 cm - A/H 73 cm - P/D 110 cm
L/W 102"3/8 - A/H 28"3/4 - P/D 43"1/4

CARTESD1802NG
CARTESD1802EM



L/W 70 cm - A/H 90 cm - P/D 10 cm
L/W 27"1/2 - A/H 35"3/8 - P/D 3"7/8

CARTESD1803MS



L/W 70 cm - A/H 90 cm - P/D 10 cm
L/W 27"1/2 - A/H 35"3/8 - P/D 3"7/8

CARTESD1803NG
CARTESD1803EM



L/W 70 cm - A/H 90 cm - P/D 10 cm
L/W 27"1/2 - A/H 35"3/8 - P/D 3"7/8

CARTESD1803CU

PANNELLI DI CORTESIA / MODESTY PANEL



L/W 134 cm - A/H 49 cm
L/W 52"3/4 - A/H 19"1/4

CARTESD1804CU



L/W 154 cm - A/H 49 cm
L/W 60"5/8 - A/H 19"1/4

CARTESD1805CU



L/W 174 cm - A/H 49 cm
L/W 68"1/2 - A/H 19"1/4

CARTESD1806CU



L/W 134 cm - A/H 49 cm
L/W 52"3/4 - A/H 19"1/4

CARTESD1804NG
CARTESD1804EM



L/W 154 cm - A/H 49 cm
L/W 60"5/8 - A/H 19"1/4





CARTESD1805NG
CARTESD1805EM



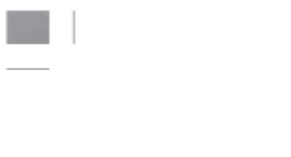

L/W 174 cm - A/H 49 cm
L/W 68"1/2 - A/H 19"1/4

CARTESD1806NG
CARTESD1806EM





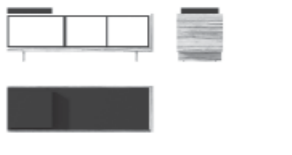

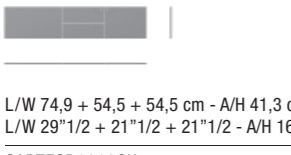
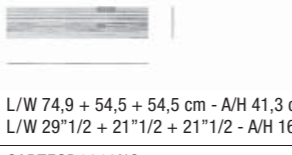
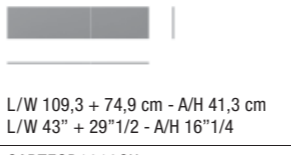
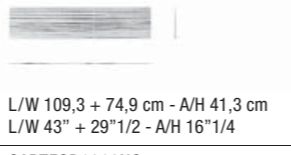
CASSETTIERE / PEDESTALS

			
L/W 62,2 cm - A/H 69 cm - P/D 73 cm L/W 24"1/2 - A/H 27"1/8 - P/D 28"3/4	L/W 62,2 cm - A/H 69 cm - P/D 73 cm L/W 24"1/2 - A/H 27"1/8 - P/D 28"3/4	L/W 55,4 cm - A/H 43,3 cm L/W 21"3/4 - A/H 17"	L/W 55,4 cm - A/H 43,3 cm L/W 21"3/4 - A/H 17"
CARTESD1807CU	CARTESD1807NG CARTESD1807EM	CARTESD1808CU	CARTESD1808NG CARTESD1808EM

MOBILI ALLUNGHI / RETURN CABINETS

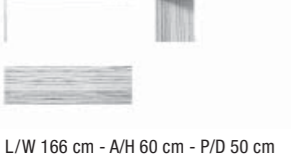
			
L/W 190 cm - A/H 69 cm - P/D 60 cm L/W 74"3/4 - A/H 27"1/8 - P/D 23"5/8	L/W 190 cm - A/H 69 cm - P/D 60 cm L/W 74"3/4 - A/H 27"1/8 - P/D 23"5/8	L/W 185 cm - A/H 2 cm - P/D 60 cm L/W 72"7/8 - A/H 3/4" - P/D 23"5/8	L/W 185 cm - A/H 2 cm - P/D 60 cm L/W 72"7/8 - A/H 3/4" - P/D 23"5/8
CARTESD1810NG CARTESD1810EM	CARTESD1809NG CARTESD1809EM	CARTESD1811NG CARTESD1811EM	CARTESD1811CU
			
L/W 74,9 + 54,5 + 54,5 cm - A/H 41,3 cm L/W 29"1/2 + 21"1/2 + 21"1/2 - A/H 16"1/4	L/W 74,9 + 54,5 + 54,5 cm - A/H 41,3 cm L/W 29"1/2 + 21"1/2 + 21"1/2 - A/H 16"1/4	L/W 109,3 + 74,9 cm - A/H 41,3 cm L/W 43" + 29"1/2 - A/H 16"1/4	L/W 109,3 + 74,9 cm - A/H 41,3 cm L/W 43" + 29"1/2 - A/H 16"1/4
CARTESD1812CU	CARTESD1812NG CARTESD1812EM	CARTESD1813CU	CARTESD1813NG CARTESD1813EM

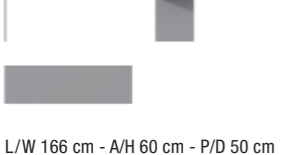
MOBILI / CABINETS

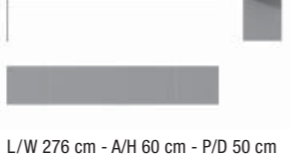
		
L/W 171 cm - A/H 78 cm - P/D 50 cm L/W 67"3/8 - A/H 30"3/4 - P/D 19"5/8	L/W 227 cm - A/H 78 cm - P/D 50 cm L/W 89"3/8 - A/H 30"3/4 - P/D 19"5/8	L/W 281 cm - A/H 78 cm - P/D 50 cm L/W 110"5/8 - A/H 30"3/4 - P/D 19"5/8
CARTESM1820NG CARTESM1820EM	CARTESM1821NG CARTESM1821EM	CARTESM1822NG CARTESM1822EM
		
L/W 166 cm - A/H 60 cm - P/D 50 cm L/W 65"3/8 - A/H 23"5/4 - P/D 19"5/8	L/W 222 cm - A/H 60 cm - P/D 50 cm L/W 87"3/8 - A/H 23"5/4 - P/D 19"5/8	L/W 276 cm - A/H 60 cm - P/D 50 cm L/W 108"5/8 - A/H 23"5/4 - P/D 19"5/8
CARTESM1823NG CARTESM1823EM	CARTESM1824NG CARTESM1824EM	CARTESM1825NG CARTESM1825EM
		
L/W 166 cm - A/H 60 cm - P/D 50 cm L/W 65"3/8 - A/H 23"5/4 - P/D 19"5/8	L/W 222 cm - A/H 60 cm - P/D 50 cm L/W 87"3/8 - A/H 23"5/4 - P/D 19"5/8	L/W 276 cm - A/H 60 cm - P/D 50 cm L/W 108"5/8 - A/H 23"5/4 - P/D 19"5/8
CARTESM1823CU	CARTESM1824CU	CARTESM1825CU

MOBILI / CABINETS

				
L/W 54,2 cm - A/H 57,6 cm L/W 21"3/8 - A/H 22"5/8	L/W 54,2 cm - A/H 57,6 cm L/W 21"3/8 - A/H 22"5/8	L/W 54,2 cm - A/H 57,6 cm L/W 21"3/8 - A/H 22"5/8	L/W 109,3 cm - A/H 57,6 cm L/W 43" - A/H 22"5/8	
CARTESM1826NG CARTESM1826EM	CARTESM1827NG CARTESM1827EM	CARTESM1828NG CARTESM1828EM	CARTESM1829NG CARTESM1829EM	
				
L/W 54,2 cm - A/H 57,6 cm L/W 21"3/8 - A/H 22"5/8	L/W 54,2 cm - A/H 57,6 cm L/W 21"3/8 - A/H 22"5/8	L/W 54,2 cm - A/H 57,6 cm L/W 21"3/8 - A/H 22"5/8	L/W 109,3 cm - A/H 57,6 cm L/W 43" - A/H 22"5/8	
CARTESM1826CU	CARTESM1827CU	CARTESM1828CU	CARTESM1829CU	
				
L/W 171 cm - A/H 97 cm - P/D 50 cm L/W 67"3/8 - A/H 38"1/4 - P/D 19"5/8	L/W 227 cm - A/H 97 cm - P/D 50 cm L/W 89"3/8 - A/H 38"1/4 - P/D 19"5/8	L/W 281 cm - A/H 97 cm - P/D 50 cm L/W 110"5/8 - A/H 38"1/4 - P/D 19"5/8		
CARTESM1830NG CARTESM1830EM	CARTESM1831NG CARTESM1831EM	CARTESM1832NG CARTESM1832EM		
				
L/W 166 cm - A/H 80 cm - P/D 50 cm L/W 65"3/8 - A/H 31"1/2 - P/D 19"5/8	L/W 222 cm - A/H 80 cm - P/D 50 cm L/W 87"3/8 - A/H 31"1/2 - P/D 19"5/8	L/W 276 cm - A/H 80 cm - P/D 50 cm L/W 108"5/8 - A/H 31"1/2 - P/D 19"5/8		
CARTESM1833NG CARTESM1833EM	CARTESM1834NG CARTESM1834EM	CARTESM1835NG CARTESM1835EM		
				
L/W 166 cm - A/H 80 cm - P/D 50 cm L/W 65"3/8 - A/H 31"1/2 - P/D 19"5/8	L/W 222 cm - A/H 80 cm - P/D 50 cm L/W 87"3/8 - A/H 31"1/2 - P/D 19"5/8	L/W 276 cm - A/H 80 cm - P/D 50 cm L/W 108"5/8 - A/H 31"1/2 - P/D 19"5/8		
CARTESM1833CU	CARTESM1834CU	CARTESM1835CU		
				
L/W 54,2 cm - A/H 77,6 cm L/W 21"3/8 - A/H 30"1/2	L/W 54,2 cm - A/H 77,6 cm L/W 21"3/8 - A/H 30"1/2	L/W 54,2 cm - A/H 77,6 cm L/W 21"3/8 - A/H 30"1/2	L/W 54,2 cm - A/H 77,6 cm L/W 21"3/8 - A/H 30"1/2	L/W 109,3 cm - A/H 77,6 cm L/W 43" - A/H 30"1/2
CARTESM1836NG CARTESM1836EM	CARTESM1837NG CARTESM1837EM	CARTESM1838NG CARTESM1838EM	CARTESM1839NG CARTESM1839EM	CARTESM1840NG CARTESM1840EM
				
L/W 54,2 cm - A/H 77,6 cm L/W 21"3/8 - A/H 30"1/2	L/W 54,2 cm - A/H 77,6 cm L/W 21"3/8 - A/H 30"1/2	L/W 54,2 cm - A/H 77,6 cm L/W 21"3/8 - A/H 30"1/2	L/W 54,2 cm - A/H 77,6 cm L/W 21"3/8 - A/H 30"1/2	L/W 109,3 cm - A/H 77,6 cm L/W 43" - A/H 30"1/2
CARTESM1836CU	CARTESM1837CU	CARTESM1838CU	CARTESM1839CU	CARTESM1840CU



▶ EUCLIDEO
DESIGN: FERRUCCIO LAVIANI







Il modello è disponibile in una sola dimensione ma con diverse finiture: pelle, cuoio, essenza tipo ebano e laccatura RAL. Altre finiture disponibili solo su richiesta.
 Il modello integra in un solo blocco sia il piano della scrivania che un mobile allungo destro o sinistro. Il piano della scrivania si appoggia a una struttura d'acciaio verniciata colore nero, realizzata con piastre dello spessore di 15 mm saldate o fissate fra di loro tramite bulloni. Questa struttura è poi fissata al mobile allungo realizzato in pannello di particelle di legno impiallacciato in essenza tipo ebano oppure in MDF laccato in uno dei colori RAL in collezione. Il lato interno dell'allungo è dotato di 3 cassetti e due ante tutti con sistema di apertura push & pull, mentre sul lato esterno è disponibile una nicchia con vano a giorno. Il piano della scrivania è realizzato in pannello di particelle impiallacciato in essenza, rivestito in cuoio o pelle oppure in MDF laccato. Sotto al piano è fissato un elemento di copertura in acciaio rivestito in cuoio nero.

*The model is available in one size but with different finishes: leather, saddle leather, ebony type wood and RAL lacquering. Other finishes available only on request.
 The model integrates in a single block both the desk top and a right or left extension unit. The desk top rests on a black painted steel frame, made with 15 mm thick plates welded or fixed together by bolts. This frame is then fixed to the return cabinet made of particle board panel veneered in ebony type wood or in lacquered MDF in one of the RAL colors of the collection. The inner side of this return cabinet is equipped with 3 drawers and two doors all with push & pull opening system, while on the external side there is a open unit with one shelf. The desk top is made of particle board panel veneered in wood, covered in leather or saddle leather or in lacquered MDF. Under the top there is a steel covering element covered in black saddle leather.*

SCRIVANIE / DESKS

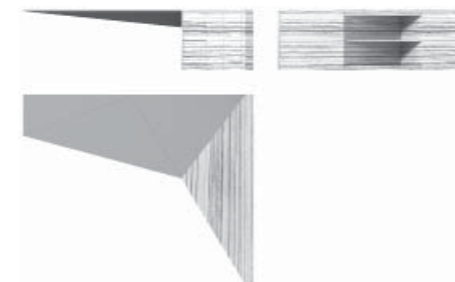

L/W 280 cm - A/H 73 cm - P/D 230 cm
 L/W 110"1/4 - A/H 28"3/4 - P/D 90"1/2

EUCLIDD1900CU



L/W 280 cm - A/H 73 cm - P/D 230 cm
 L/W 110"1/4 - A/H 28"3/4 - P/D 90"1/2

EUCLIDD1901CU



L/W 280 cm - A/H 73 cm - P/D 230 cm
 L/W 110"1/4 - A/H 28"3/4 - P/D 90"1/2

EUCLIDD1902EB



L/W 280 cm - A/H 73 cm - P/D 230 cm
 L/W 110"1/4 - A/H 28"3/4 - P/D 90"1/2

EUCLIDD1903EB

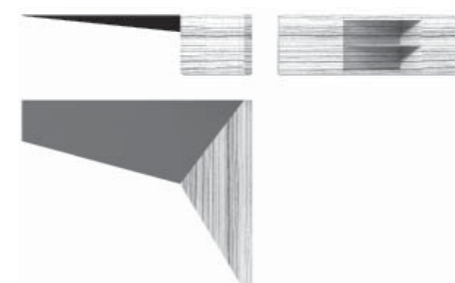

L/W 280 cm - A/H 73 cm - P/D 230 cm
 L/W 110"1/4 - A/H 28"3/4 - P/D 90"1/2

EUCLIDD1904LA



L/W 280 cm - A/H 73 cm - P/D 230 cm
 L/W 110"1/4 - A/H 28"3/4 - P/D 90"1/2

EUCLIDD1905LA

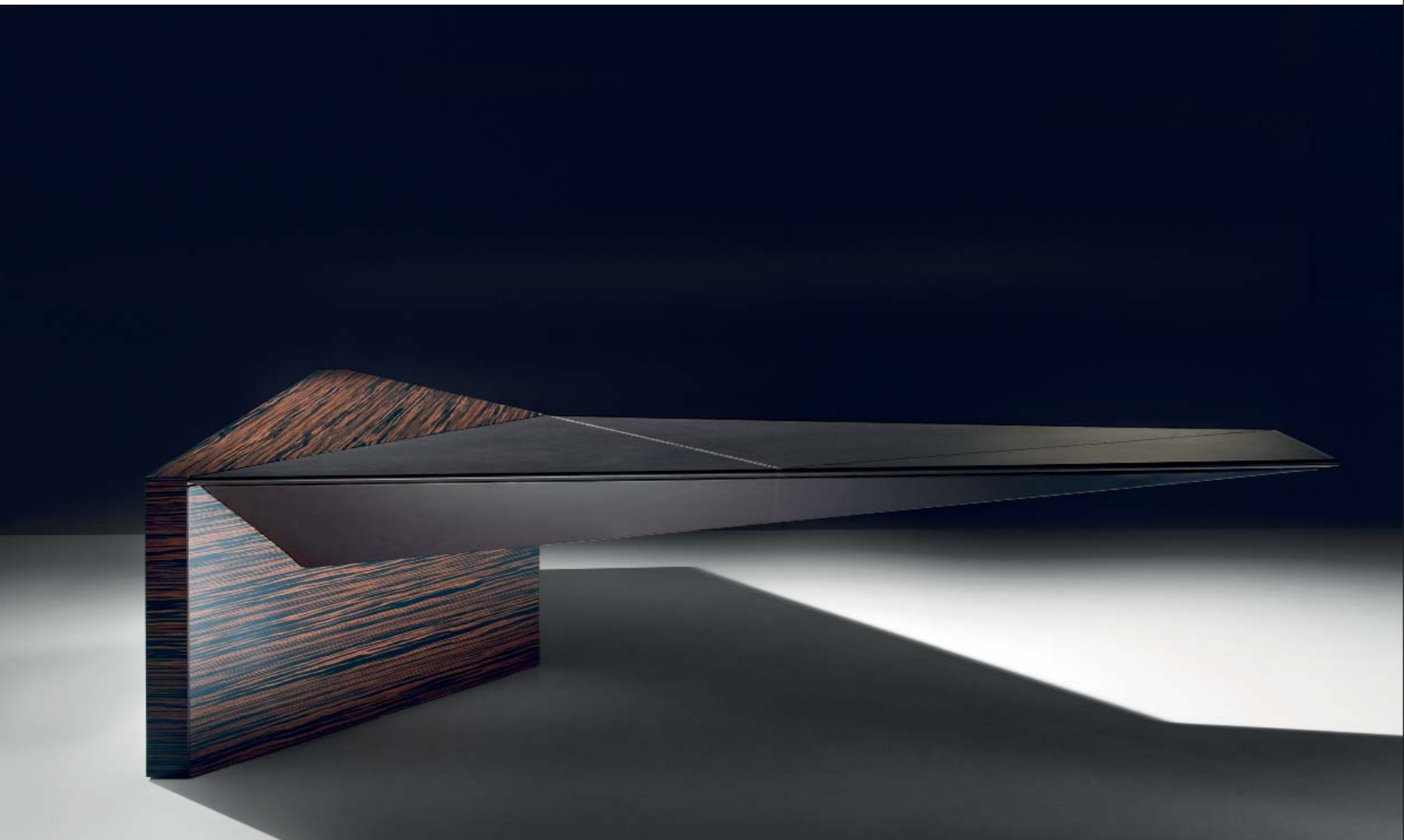



KEFA

DESIGN: MATTEO NUNZIATI





Finiture: Eucalipto e Cuoio CF 04.
Finishings: Eucalyptus Wood and Saddle Leather CF 04.





Finiture: Rovere Titanio e Cuoio CF 26.
Finishings: Titanium Oak Wood and Saddle Leather CF 26.





Finiture: Ebano Macassar e Cuoio CF 27.
Finishings: Macassar Ebony Wood and Saddle Leather CF 27.





Finiture: Noce canaletto fiammato e cuoio CF 01.
Finishings: *Veined Black Walnut Wood and Saddle Leather CF 01.*

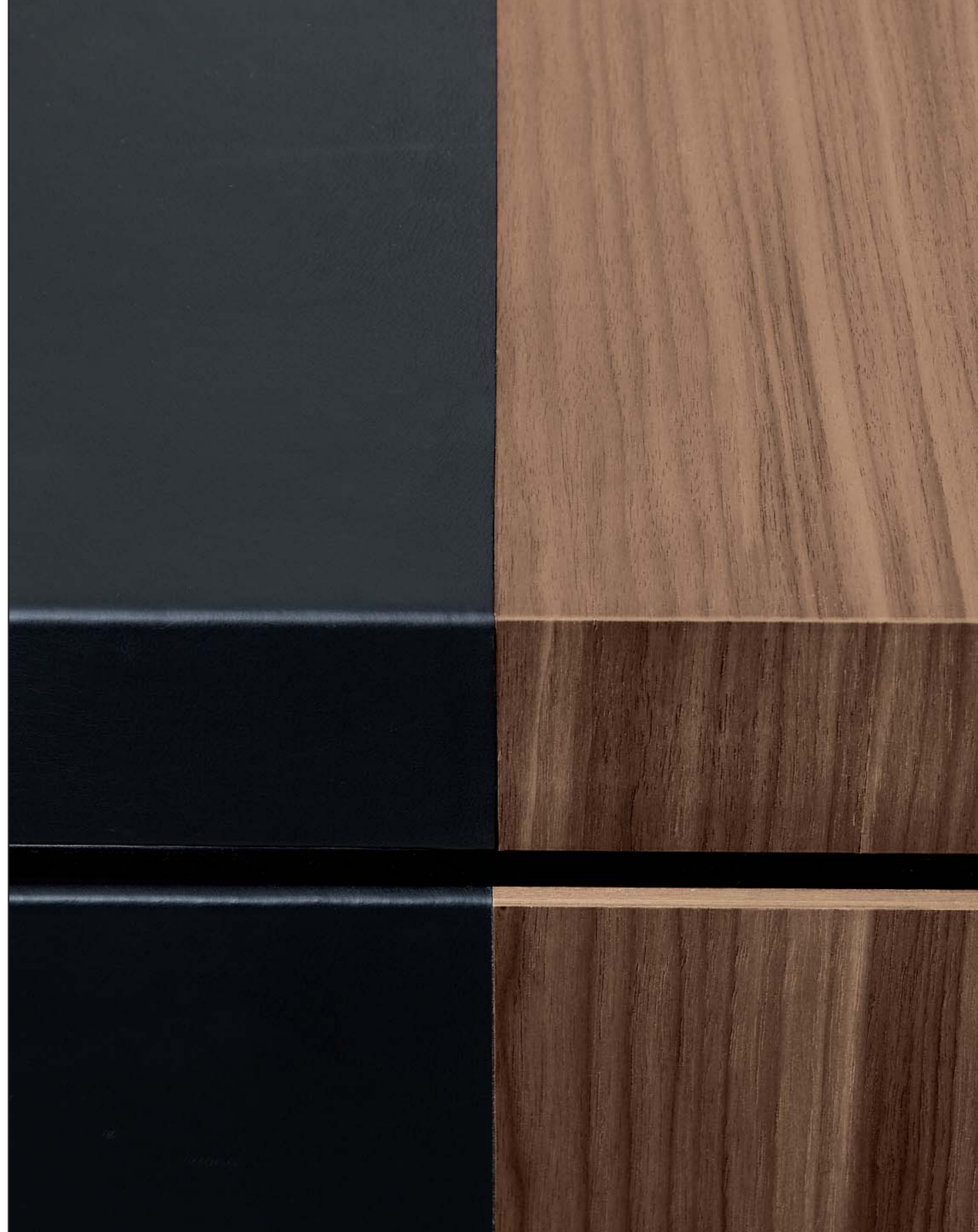



Il modello KEFA è disponibile in molte diverse varianti e finiture che utilizzano i seguenti materiali principali: pelle, cuoio, essenza di noce canaletto con effetto cera, essenza di rovere grigio Titanium Oak e essenza di eucalipto spazzolato con effetto cera. Le poltrone sono disponibili in pelle con basamento verniciato titanio. Altre finiture disponibili solo su richiesta.

I piani e le gambe delle scrivanie e dei tavoli riunione sono realizzati in pannello tamburato con bordi e traversi in massello di faggio, cartone a nido d'ape spessore 42 mm e due pannelli con spessore 8 mm sulle due facce nelle finiture pelle, cuoio o essenza. I piani e le gambe sono disponibili nella versione parzialmente in cuoio e parzialmente in essenza. I piani delle scrivanie sono dotate di serie di una scatola elettrificata con 2x prese di corrente universali, 2x USB, 1x Audio 3.5, 1x HDMI, 2x RJ45 con tappo di copertura rivestito in cuoio o pelle. Le gambe sono fissate al piano con delle spine cilindriche di legno e con delle viti eccentriche. Inoltre sotto al piano è posizionato un traverso con spessore 36 mm per rendere stabile la scrivania o il tavolo riunione. Il pannello di cortesia ha uno spessore 19 mm ed è disponibile in tutte le finiture. La gamba della scrivania può essere sostituita nella sua funzione di sostegno del piano da un mobile cassetiera o da un mobile allungo fissi. La cassetiera e l'allungo fissi hanno una struttura con il top in cuoio o pelle o in essenza. I frontali sono costituiti da pannelli, ante o cassetti disponibili nelle medesime finiture; le maniglie sono costituite da un profilato di alluminio verniciato colore titanio. I cassetti sono in pannello multistrato di faggio laccati nero opaco con delle guide in acciaio con chiusura ammortizzata. I mobili sono disponibili in due altezze (805 mm o 1840 mm). Le strutture dei mobili bassi e alti sono realizzate sempre in nobilitato nero spessore 19 mm; il top superiore ed i fianchi sono disponibili in cuoio o pelle e in essenza. I frontali dei mobili bassi e alti sono costituiti da cassetti ed ante di varie dimensioni e sono disponibili in cuoio o pelle o in essenza. Le maniglie sono sempre in profilato di alluminio verniciato colore titanio. I ripiani interni sono sempre realizzati in nobilitato nero mentre i cassetti sono in pannello multistrato di faggio laccati nero opaco con delle guide in acciaio con richiamo ammortizzato. Le poltrone hanno una struttura per la seduta ed i braccioli separata da quella dello schienale e costituita da un tubolare d'acciaio; entrambe sono annegate in uno stampo di poliuretano schiumato a freddo con densità di 60 Kg/m3; tale prodotto nudo così ottenuto risulta ignifugo in Classe 11M secondo la normativa vigente italiana e disponibile su richiesta e con sovrapprezzo per altre normative internazionali. Le poltrone hanno un basamento a 5 razze in alluminio pressofuso verniciato colore titanio e sono girevoli, regolabili in altezza tramite pistone a gas e dotate di meccanismo ergonomico.

The Kefa model is available in many different versions and finishes that uses mainly the following materials: leather, saddle leather, black walnut veneer with wax natural finishing, Titanium Oak veneer, brushed eucalyptus veneer with wax natural finishing. The armchair are available in leather with base varnished in titanium color. Other finishing available on request.

The tops and legs of desks and conference table are made of honeycomb fiberboard with edges and crossbars in beechwood, honeycomb cardboard with thickness 42 mm and two panels each one 8 mm on the 2 faces available in the finishing leather, saddle leather or wood veneer. Tops and legs are available in the version partially in leather or saddle leather and partially in wood veneer. Tops of the desks are equipped with a plug box with 2x universal power sockets, 2x USB, 1x Audio 3.5, 1x HDMI, 2x RJ45 with top covered in leather or saddle leather. The legs are fixed to the top with some cylindrical wood dowels and with some eccentric screws. Furthermore under the top, between the two legs is fixed a cross with thickness 36 mm in order to give solidity to the desk or to the conference table. The modesty panel has a thickness of 19 mm and is available in all the finishing. The leg of the desk, in its function to support the top, can be replaced with a fixed pedestal cabinet or by a fixed sideboard cabinet. The fixed pedestal and the fixed sideboard cabinet have a frame with the top in leather or saddle leather or in wood veneer. The fronts are composed by panels, doors and drawers available in the standard finishing; the handles are made with Titanium color varnished aluminum profile. The drawers are in beech plywood panel black matt lacquered with steel slide runners with damped close. The cabinets are available in two heights (805 mm. or 1840 mm). The frames of the low and high cabinets are made always in black melamine coated panels thickness 19 mm; the upper top and the sides are available in leather, saddle leather, or wood veneer. The fronts of the low and high cabinets – drawers and doors in different dimensions – are available in leather, saddle leather or wood veneer. The handles are always in Titanium color varnished aluminum profile. The internal shelves are always in black melamine coated panels while the drawers are in beech plywood panel black matt lacquered with steel slide runners with damped close. The armchairs have the frame for the seat and for the arms separated from the backrest frame. Both have a frame in tubular steel embedded in a polyurethane cold formed in mould with density of 60 Kg/m3; this naked foam item comply to the Italian Classe 11M fire resistant laws and is also available on demand and with extra rate for other international standards. The base is available in a 5 star swivel base on casters in aluminum titanium color varnished; armchairs are adjustable in height through a gas-piston and equipped with an ergonomic mechanism.

POLTRONE / ARMCHAIRS



L/W 71 cm - A/H 125-132 cm - a/h 48-55 cm - P/D 61 cm
L/W 28" - A/H 49"1/4-52" cm - a/h 18"7/8-21"5/8 - P/D 24"

KEFA00POL1770



L/W 71 cm - A/H 102-109 cm - a/h 48-55 cm - P/D 61 cm
L/W 28" - A/H 40"1/8-42"7/8 cm - a/h 18"7/8-21"5/8 - P/D 24"

KEFA00POL1771

PIANI SCRIVANIE / TOP OF DESKS



L/W 220 cm - A/H 5,8 cm - P/D 100 cm
L/W 86"5/8 - A/H 2"1/4 - P/D 39"3/8

KEFA00D1700EU
KEFA00D1700NO
KEFA00D1700TI

KEFA00D1701CU

KEFA00D1701EU
KEFA00D1701NO
KEFA00D1701TI

L/W 240 cm - A/H 5,8 cm - P/D 100 cm
L/W 94"1/2 - A/H 2"1/4 - P/D 39"3/8

KEFA00D1702EU
KEFA00D1702NO
KEFA00D1702TI

KEFA00D1703EU
KEFA00D1703NO
KEFA00D1703TI

KEFA00D1703CU



L/W 240 cm - A/H 5,8 cm - P/D 120 cm
L/W 94"1/2 - A/H 2"1/4 - P/D 47"1/4

KEFA00D1704EU
KEFA00D1704NO
KEFA00D1704TI

KEFA00D1705CU

KEFA00D1705EU
KEFA00D1705NO
KEFA00D1705TI

L/W 260 cm - A/H 5,8 cm - P/D 120 cm
L/W 102"3/8 - A/H 2"1/4 - P/D 47"1/4

KEFA00D1706EU
KEFA00D1706NO
KEFA00D1706TI

KEFA00D1707EU
KEFA00D1707NO
KEFA00D1707TI

KEFA00D1707CU

GAMBE PER PIANI DI SCRIVANIA / LEGS FOR TOP OF THE DESK



L/W 100 cm - A/H 68 cm - P/D 5,8 cm
L/W 39"3/8 - A/H 26"3/4 - P/D 2"1/4

KEFA00D1708EU
KEFA00D1708NO
KEFA00D1708TI

KEFA00D1709CU

KEFA00D1709EU
KEFA00D1709NO
KEFA00D1709TI

L/W 120 cm - A/H 68 cm - P/D 5,8 cm
L/W 47"1/4 - A/H 26"3/4 - P/D 2"1/4

KEFA00D1710EU
KEFA00D1710NO
KEFA00D1710TI

KEFA00D1711EU
KEFA00D1711NO
KEFA00D1711TI

KEFA00D1711CU

PANNELLI DI CORTESIA / MODESTY PANEL



L/W 149 cm - A/H 59 cm
L/W 58"5/8 - A/H 23"1/4

KEFA00D1712EU
KEFA00D1712NO
KEFA00D1712TI

L/W 169 cm - A/H 59 cm
L/W 66"1/2 - A/H 23"1/4

KEFA00D1713EU
KEFA00D1713NO
KEFA00D1713TI

L/W 189 cm - A/H 59 cm
L/W 74"3/8 - A/H 23"1/4

KEFA00D1714EU
KEFA00D1714NO
KEFA00D1714TI

KEFA00D1714CU

TAVOLI RIUNIONE / CONFERENCE TABLES

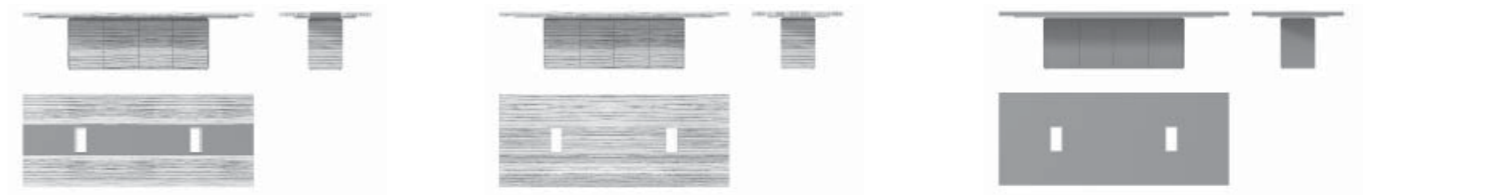

L/W 300 cm - A/H 74 cm - P/D 120 cm
L/W 118"1/8 - A/H 29"1/8 - P/D 47"1/4

KEFA00D1715EU
KEFA00D1715NO
KEFA00D1715TI

L/W 300 cm - A/H 74 cm - P/D 120 cm
L/W 118"1/8 - A/H 29"1/8 - P/D 47"1/4

KEFA00D1716EU
KEFA00D1716NO
KEFA00D1716TI

L/W 300 cm - A/H 74 cm - P/D 120 cm
L/W 118"1/8 - A/H 29"1/8 - P/D 47"1/4

KEFA00D1718CU



L/W 130 cm - A/H 73,8 cm - P/D 130 cm
L/W 51"1/8 - A/H 29" - P/D 51"1/8

KEFA00D1717EU
KEFA00D1717NO
KEFA00D1717TI

L/W 130 cm - A/H 73,8 cm - P/D 130 cm
L/W 51"1/8 - A/H 29" - P/D 51"1/8

KEFA00D1718EU
KEFA00D1718NO
KEFA00D1718TI

L/W 130 cm - A/H 73,8 cm - P/D 130 cm
L/W 51"1/8 - A/H 29" - P/D 51"1/8

KEFA00D1718CU

CASSETTIERE / PEDESTALS



L/W 80 cm - A/H 68 cm - P/D 107,5 cm
L/W 31"1/2 - A/H 26"3/4 - P/D 42"3/8

KEFA00M1720EU KEFA00M1720CU
KEFA00M1720NO KEFA00M1720TI

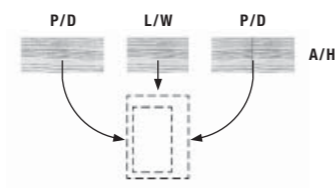

L/W 80 cm - A/H 47 cm - P/D 107,5 cm
L/W 31"1/2 - A/H 18"1/2 - P/D 42"3/8

KEFA00M1721EU KEFA00M1721NO
KEFA00M1721TI

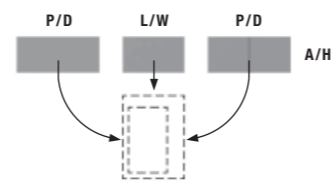

L/W 80 cm - A/H 47 cm - P/D 107,5 cm
L/W 31"1/2 - A/H 18"1/2 - P/D 42"3/8

KEFA00M1721CU



L/W 80 cm - A/H 68 cm - P/D 127,5 cm
L/W 31"1/2 - A/H 26"3/4 - P/D 50"1/4

KEFA00M1722EU KEFA00M1722CU
KEFA00M1722NO KEFA00M1722TI

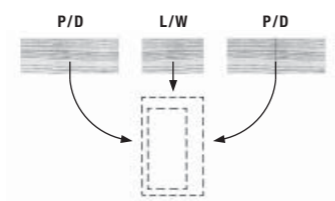

L/W 80 cm - A/H 47 cm - P/D 127,5 cm
L/W 31"1/2 - A/H 18"1/2 - P/D 50"1/4

KEFA00M1723EU KEFA00M1723NO
KEFA00M1723TI

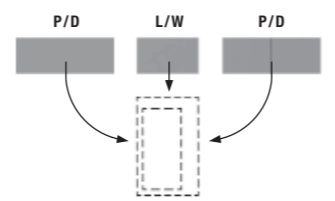

L/W 80 cm - A/H 47 cm - P/D 127,5 cm
L/W 31"1/2 - A/H 18"1/2 - P/D 50"1/4

KEFA00M1723CU



L/W 75,4 cm - A/H 47 cm
L/W 29"5/8 - A/H 18"1/2

KEFA00M1724EU KEFA00M1724CU
KEFA00M1724NO KEFA00M1724TI



L/W 75,4 cm - A/H 47 cm
L/W 29"5/8 - A/H 18"1/2

KEFA00M1725EU KEFA00M1725CU
KEFA00M1725NO KEFA00M1725TI

MOBILI ALLUNGHI / RETURN CABINETS



L/W 225,5 cm - A/H 68 cm - P/D 80 cm
L/W 88"3/4 - A/H 26"3/4 - P/D 31"1/2

KEFA00M1726EU KEFA00M1726CU
KEFA00M1726NO KEFA00M1726TI

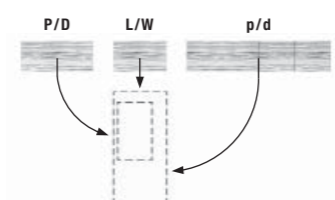

L/W 80 cm - A/H 47 cm - P/D 112 cm - p/d 222 cm
L/W 31"1/2 - A/H 18"1/2 - P/D 44"1/8 - p/d 87"3/8

KEFA00M1727EU KEFA00M1727NO
KEFA00M1727TI

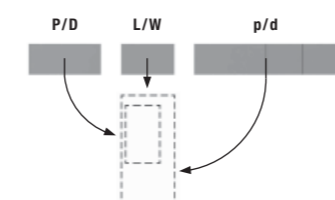

L/W 80 cm - A/H 47 cm - P/D 112 cm - p/d 222 cm
L/W 31"1/2 - A/H 18"1/2 - P/D 44"1/8 - p/d 87"3/8

KEFA00M1727CU



L/W 54,6 cm - A/H 47 cm
L/W 21"1/2 - A/H 18"1/2

KEFA00M1728EU KEFA00M1728CU
KEFA00M1728NO KEFA00M1728TI



L/W 54,6 cm - A/H 47 cm
L/W 21"1/2 - A/H 18"1/2

KEFA00M1729EU KEFA00M1729NO
KEFA00M1729TI



L/W 54,6 cm - A/H 47 cm
L/W 21"1/2 - A/H 18"1/2

KEFA00M1730EU KEFA00M1730NO
KEFA00M1730TI



L/W 54,6 cm - A/H 47 cm
L/W 21"1/2 - A/H 18"1/2

KEFA00M1730CU

MOBILI BASSI / LOW CABINETS



L/W 170 cm - A/H 80,5 cm - P/D 50 cm
L/W 66"7/8 - A/H 31"3/4 - P/D 19"5/8

KEFA00M1731EU KEFA00M1731CU
KEFA00M1731NO KEFA00M1731TI



L/W 226 cm - A/H 80,5 cm - P/D 50 cm
L/W 89" - A/H 31"3/4 - P/D 19"5/8

KEFA00M1732EU KEFA00M1732NO
KEFA00M1732TI KEFA00M1732CU



L/W 282 cm - A/H 80,5 cm - P/D 50 cm
L/W 111" - A/H 31"3/4 - P/D 19"5/8

KEFA00M1733EU KEFA00M1733CU
KEFA00M1733NO KEFA00M1733TI

MOBILI ALTI / HIGH CABINETS



L/W 118 cm - A/H 184 cm - P/D 50 cm
L/W 46"1/2 - A/H 72"1/2 - P/D 19"5/8

KEFA00M1734EU KEFA00M1734CU
KEFA00M1734NO KEFA00M1734TI



L/W 174 cm - A/H 184 cm - P/D 50 cm
L/W 68"1/2 - A/H 72"1/2 - P/D 19"5/8

KEFA00M1735EU KEFA00M1735NO
KEFA00M1735TI KEFA00M1735CU



L/W 230 cm - A/H 184 cm - P/D 50 cm
L/W 90"1/2 - A/H 72"1/2 - P/D 19"5/8

KEFA00M1736EU KEFA00M1736CU
KEFA00M1736NO KEFA00M1736TI



L/W 54,5 cm - A/H 179 cm
L/W 21"1/2 - A/H 70"1/2

KEFA00M1742EU KEFA00M1742CU
KEFA00M1742NO KEFA00M1742TI



L/W 54,2 cm - A/H 76,1 cm
L/W 21"3/8 - A/H 30"

KEFA00M1737EU KEFA00M1737CU
KEFA00M1737NO KEFA00M1737TI



L/W 54,2 cm - A/H 76,1 cm
L/W 21"3/8 - A/H 30"

KEFA00M1739EU KEFA00M1739NO
KEFA00M1739TI



L/W 54,2 cm - A/H 76,1 cm
L/W 21"3/8 - A/H 30"

KEFA00M1740EU KEFA00M1740NO
KEFA00M1740TI



L/W 54,2 cm - A/H 76,1 cm
L/W 21"3/8 - A/H 30"

KEFA00M1741EU KEFA00M1741NO
KEFA00M1741TI



▶ AVATAR
DESIGN: UMBERTO ASNAGO





Finiture: essenza tipo palissandro e cuoio CF 01.
Finisings: rosewood type veneer and saddle leather CF 01.





Finiture: noce canaletto rigato e pelle PF 4016.
Finishings: striped black walnut wood and leather PF 4016.











Finiture: essenza tipo ebano e pelle PF 4134.
Finishings: ebony type Veneer and leather PF 4134.







Finiture: noce canaletto rigato con venatura incrociata e finitura lucida 100 gloss. Pelle PX Woodstock.
Finishings: striped black walnut wood with crossed veneer with hi-gloss finishing with 100 gloss. Leather PX Woodstock.



Il modello AVATAR è disponibile in moltissime varianti liberamente combinabili fra loro che di serie impiegano due materiali principali:

- Cuoio o pelle. Il cuoio o la pelle sono sempre applicati a pannelli di nobilitato nero di spessore variabile a seconda dell'utilizzo.
- Essenza di legno noce canaletto o tipo ebano. Le due essenze sono impiallacciate a pannelli di particelle di legno di spessore variabile a seconda dell'utilizzo. È disponibile di serie anche l'impiallaccatura intarsiata a quadrotti per i piani delle scrivanie e per le ante dei mobili. Il modello è disponibile a richiesta anche in una delle altre finiture di essenza in collezione.

I piani delle scrivanie e dei tavoli riunione sono costituiti da un subtop di 40 mm. in nobilitato nero con bordi arrotondati e rivestiti in cuoio o pelle, e da un top di 20 mm. di spessore che può essere rivestito in cuoio o pelle oppure impiallacciato; nel caso di top in essenza nella parte centrale è presente un sottomano rivestito in cuoio o pelle.

Sotto ai subtop sono applicate delle barre raddrizzanti.

Le gambe sono costituite da due elementi simmetrici incollati fra di loro e realizzati in poliuretano rigido in un opportuno stampo ed in seguito rivestite in cuoio o pelle. Eventualmente il buco decorativo delle stesse può essere chiuso con due pannelli di particelle di legno impiallacciati o rivestiti in cuoio o pelle. Alla base delle gambe è fissata una piastra d'acciaio verniciata nera con dimensioni diverse a seconda che la gamba sia per la scrivania o per il tavolo riunione rettangolare. I tavoli riunione tondi hanno una gamba in pannello di particelle di legno sempre rivestita in cuoio o pelle ed una base in acciaio verniciato nero.

Il pannello di cortesia è costituito da un pannello nobilitato di 20 mm. impiallacciato con una parte centrale rivestita in cuoio o pelle.

La gamba può essere sostituita nella sua funzione di sostegno del piano da un mobile cassetiera o da un mobile allungo fissi su cui poggia il subtop.

La cassetiera fissa è disponibile completamente rivestita in cuoio o pelle. I frontali della cassetiera così come l'anta lato ospiti (con meccanismo di apertura push & pull) sono disponibili rivestiti in cuoio o pelle oppure impiallacciati. I bordi del basamento ed del top della cassetiera sono sempre impiallacciati.

Il mobile allungo ha una struttura in pannello nobilitato nero con diversi spessori ed è usufruibile da entrambe i lati. Il piano superiore di appoggio è sempre impiallacciato così come il bordo del basamento. Sia il lato interno che quello esterno sono completati con un pannello di chiusura, disponibile rivestito in cuoio o pelle o impiallacciato, e da due vani; per i due vani esterni sono disponibili solo ante rivestite in cuoio o pelle o impiallacciate (con sistema di apertura push & pull), mentre per i due vani interni dell'allungo sono disponibili sia ante che cassetti e classificatori rivestiti in cuoio o pelle o impiallacciati.

Le maniglie sono realizzate con un massello di noce canaletto che viene incollato con spine cilindriche al pannello di particelle di legno che costituisce l'anta o il cassetto. Queste maniglie sono disponibili in noce canaletto oppure verniciate nero opaco.

Le strutture dei mobili bassi intermedi e alti sono realizzate in nobilitato nero con spessore fra 8 e 20 mm.; ad esse sono applicate delle spalle di chiusura con spessore 4 cm in nobilitato nero rivestite sempre in cuoio o pelle. Il top è costituito da un pannello di 20 mm impiallacciato.

I cassetti, i classificatori e le ante di diversa misura sono disponibili rivestiti in cuoio o pelle oppure impiallacciati.

La scaffalatura a giorno dei mobili alti ha la struttura sempre impiallacciata con lo schienale rivestito in cuoio o pelle.

I tavolini sono costituiti da un piano di spessore 20 mm. rivestito in cuoio o pelle o impiallacciato; le gambe sono sempre rivestite in cuoio o pelle.

AVATAR is available in several combinations that use two kind of materials:

- Saddle leather or leather. The saddle leather and leather are always applied to black melamine coated panels, of various thickness, in accordance with the use.
- Black walnut wood or similar ebony wood. These two woods are veneered to particleboard panels, of variable thickness, in accordance with the use. It is also available the inlay veneer with square opposite shape for the top of desk and for the doors. On request, the model is also available in any other wood finishing of the collection.

The tops of the desks and the conference tables are composed by a black melamine coated panel subtop with thickness of 40 mm. with rounded edges covered in saddle leather or leather, and by a subtop with thickness of 20 mm. that can be covered in saddle leather or leather or veneered; in case of veneered top there is a central inlay covered in saddle leather or leather.

Under the subtops there are reinforcement steel bars.

The legs are composed by two symmetric pieces glued one to the other, made of rigid polyurethane cold formed in mould and after covered in saddle leather or leather. Eventually the decorative hole in the middle of the leg can be closed with two particleboard panels covered in saddle leather or leather or veneered. At the base of the leg is fixed a metal sheet black painted with different dimension according to the desk or to the conference table.

The round conference table has a central leg made in particle board panel covered in saddle leather or in leather with a round black varnished metal sheet.

The modesty panel is produced with a particleboard panel 20 mm thickness veneered with a central inlay covered in saddle leather or leather.

The leg, in its function of supporting the top, can be replaced with a pedestal cabinet or with a return sideboard cabinet which leans on the subtop.

The fixed pedestal is available completely covered in saddle leather or leather.

The fronts of the pedestal as well as the hidden door of the visitor's side (with opening system push & pull) are available veneered or covered in saddle leather or leather. The edges of the top and of the base of the fixed pedestal are always veneered.

The return sideboard cabinet has a frame in black melamine coated panels of different thicknesses and can be accessed from both sides. The top is always veneered as well as the edges of the base. Both the internal as well as the external sides are completed with a closing panel - available covered in saddle leather, leather or veneered - and with two units; for the two external units are available just doors covered in saddle leather, leather or veneered (with the push & pull opening system) while for the two internal units are available also drawers and files covered in saddle leather, in leather or veneered.

The handles are made with an inlay of solid black walnut wood glued with cylindrical dowels to the particleboard panel that compose the door or the drawer. These handles are available in black walnut wood or black matt varnished.









The frames of the low, middle and high cabinets are made in black melamine coated panels with thickness between 8 and 20mm. The side panels are fixed to frames and have a thickness of 4 cm in black coated panels covered in saddle leather or leather. The top is made of a panel 20 mm thickness veneered.

The drawers and file drawers and the doors are available covered in saddle leather, leather or veneered.

The open cabinet frame is always veneered with the back panel covered in saddle leather or leather.

The low tables are made with a panel of 20 mm thickness veneered or covered in saddle leather or leather while the legs are always covered in saddle leather or leather.



PIANI SCRIVANIE / TOP OF DESKS

		
L/W 220 cm - A/H 6 cm - P/D 120 cm L/W 86"5/8 - A/H 2"3/8 - P/D 47"1/4 AVATARD1600CU	L/W 220 cm - A/H 6 cm - P/D 120 cm L/W 86"5/8 - A/H 2"3/8 - P/D 47"1/4 AVATARD1600ES	L/W 220 cm - A/H 6 cm - P/D 120 cm L/W 86"5/8 - A/H 2"3/8 - P/D 47"1/4 AVATARD1650CU
		
L/W 240 cm - A/H 6 cm - P/D 120 cm L/W 94"1/2 - A/H 2"3/8 - P/D 47"1/4 AVATARD1601CU	L/W 240 cm - A/H 6 cm - P/D 120 cm L/W 94"1/2 - A/H 2"3/8 - P/D 47"1/4 AVATARD1601ES	L/W 240 cm - A/H 6 cm - P/D 120 cm L/W 94"1/2 - A/H 2"3/8 - P/D 47"1/4 AVATARD1651CU
		
L/W 265 cm - A/H 6 cm - P/D 120 cm L/W 104"3/8 - A/H 2"3/8 - P/D 47"1/4 AVATARD1602CU	L/W 265 cm - A/H 6 cm - P/D 120 cm L/W 104"3/8 - A/H 2"3/8 - P/D 47"1/4 AVATARD1602ES	L/W 265 cm - A/H 6 cm - P/D 120 cm L/W 104"3/8 - A/H 2"3/8 - P/D 47"1/4 AVATARD1652CU







GAMBE PER PIANI DI SCRIVANIA / LEGS FOR TOP OF THE DESK

		
L/W 82 cm - A/H 68 cm - P/D 33,5 cm L/W 32"1/4 - A/H 26"3/4 - P/D 13"1/4 AVATARD1604CU	AVATARD1606CU	AVATARD1606ES

ESTENSIONE FRONTALE / FRONT EXTENSION

		
L/W 100 cm - A/H 74 cm - P/D 100 cm L/W 39"3/8 - A/H 29"1/8 - P/D 39"3/8 AVATARD1653CU	L/W 100 cm - A/H 74 cm - P/D 100 cm L/W 39"3/8 - A/H 29"1/8 - P/D 39"3/8 AVATARD1653ES	L/W 60,5 cm - A/H 66,9 cm - P/D 110 cm L/W 23"3/4 - A/H 26"3/8 - P/D 43"1/4 AVATARM1607CU



CASSETTI E ANTE PER CASSETTIERA FISSA / DOOR AND DRAWERS FOR FIXED PEDESTAL

					
L/W 51,6 cm - A/H 61 cm L/W 20"3/8 - A/H 24" AVATARM1608CU	L/W 51,6 cm - A/H 61 cm L/W 20"3/8 - A/H 24" AVATARM1608ES	L/W 51,6 cm - A/H 61 cm L/W 20"3/8 - A/H 24" AVATARM1609CU	L/W 51,6 cm - A/H 61 cm L/W 20"3/8 - A/H 24" AVATARM1609ES	L/W 51,6 cm - A/H 61 cm L/W 20"3/8 - A/H 24" AVATARM1610CU	L/W 51,6 cm - A/H 61 cm L/W 20"3/8 - A/H 24" AVATARM1610ES





MOBILE ALLUNGO / RETURN CABINET

L/W 228,5 cm - A/H 66,9 cm - P/D 60 cm L/W 90" - A/H 26"3/8 - P/D 23"5/8 AVATARM1611CU

PANNELLI DI CORTESIA / MODESTY PANELS

		
L/W 89 cm - A/H 64,2 cm - P/D 2 cm L/W 35" - A/H 25"1/4 - P/D 3/4" AVATARD1654ES	L/W 109 cm - A/H 64,2 cm - P/D 2 cm L/W 42"7/8 - A/H 25"1/4 - P/D 3/4" AVATARD1655ES	L/W 134 cm - A/H 64,2 cm - P/D 2 cm L/W 52"3/4 - A/H 25"1/4 - P/D 3/4" AVATARD1656ES

ANTE E CASSETTI PER MOBILE ALLUNGO / DOOR AND DRAWERS FOR RETURN CABINET

					
L/W 54,5 cm - A/H 61 cm L/W 21"1/2 - A/H 24" AVATARM1612CU	L/W 54,5 cm - A/H 61 cm L/W 21"1/2 - A/H 24" AVATARM1612ES	L/W 54,5 cm - A/H 61 cm L/W 21"1/2 - A/H 24" AVATARM1613CU	L/W 54,5 cm - A/H 61 cm L/W 21"1/2 - A/H 24" AVATARM1613ES	L/W 54,5 cm - A/H 61 cm L/W 21"1/2 - A/H 24" AVATARM1614CU	L/W 54,5 cm - A/H 61 cm L/W 21"1/2 - A/H 24" AVATARM1614ES

PANNELLI PER MOBILE ALLUNGO / PANELS FOR RETURN CABINET

			
L/W 109,7 cm - A/H 61 cm L/W 43"1/4 - A/H 24" AVATARM1615CU	L/W 109,7 cm - A/H 61 cm L/W 43"1/4 - A/H 24" AVATARM1615ES	L/W 109,7 cm - A/H 61 cm L/W 43"1/4 - A/H 24" AVATARM1616CU	L/W 109,7 cm - A/H 61 cm L/W 43"1/4 - A/H 24" AVATARM1616ES

PIANI PER TAVOLI RIUNIONE / TOP FOR CONFERENCE TABLES



L/W 300 cm - A/H 6 cm - P/D 120 cm
L/W 118"1/8 - A/H 2"3/8 - P/D 47"1/4

AVATARD1603CU

L/W 300 cm - A/H 6 cm - P/D 120 cm
L/W 118"1/8 - A/H 2"3/8 - P/D 47"1/4

AVATARD1603ES

GAMBE PER TAVOLI RIUNIONE/ LEGS FOR CONFERENCE TABLES



L/W 99 cm - A/H 69 cm - P/D 66 cm
L/W 39" - A/H 27"1/8 - P/D 26"1/4

AVATARD1605CU

TAVOLI RIUNIONE / CONFERENCE TABLES



L/W 130 cm - A/H 76 cm - P/D 130 cm
L/W 51"1/4 - A/H 29"7/8 - P/D 51"1/4

AVATARD1657CU

L/W 130 cm - A/H 76 cm - P/D 130 cm
L/W 51"1/4 - A/H 29"7/8 - P/D 51"1/4

AVATARD1657ES

MOBILI BASSI / LOW CABINETS



L/W 172,5 cm - A/H 82,5 cm - P/D 50 cm
L/W 67"7/8 - A/H 32"1/2 - P/D 19"5/8

AVATARM1617CU

L/W 228,5 cm - A/H 82,5 cm - P/D 50 cm
L/W 90" - A/H 32"1/2 - P/D 19"5/8

AVATARM1618CU

L/W 284,5 cm - A/H 82,5 cm - P/D 50 cm
L/W 112" - A/H 32"1/2 - P/D 19"5/8

AVATARM1619CU

MOBILI INTERMEDI / MEDIUM CABINETS



L/W 228,5 cm - A/H 119,5 cm - P/D 50 cm
L/W 90" - A/H 47" - P/D 19"5/8

AVATARM1625CU

STRUTTURA PER MOBILE ALTO / FRAME FOR HIGH CABINET



L/W 56 cm - A/H 198,5 cm - P/D 50 cm
L/W 22" - A/H 78"1/8 - P/D 19"5/8

AVATARM1626CU

PANNELLO LATERALE / SIDE PANEL



L/W 4,2 cm - A/H 193 cm - P/D 50 cm
L/W 1"5/8 - A/H 76" - P/D 19"5/8

AVATARM1627CU

TOP PER MOBILI ALTI / TOP FOR HIGH CABINET



L/W 118,4 cm - A/H 2 cm - P/D 50 cm
L/W 46"5/8 - A/H 3/4" - P/D 19"5/8

AVATARM1633ES

L/W 178,4 cm - A/H 2 cm - P/D 50 cm
L/W 70"1/4 - A/H 3/4" - P/D 19"5/8

AVATARM1634ES

L/W 228,5 cm - A/H 2 cm - P/D 50 cm
L/W 90" - A/H 3/4" - P/D 19"5/8

AVATARM1635ES

MOBILI ALTI / HIGH CABINETS



L/W 118,5 cm - A/H 198,5 cm - P/D 50 cm
L/W 46"5/8 - A/H 78"1/8 - P/D 19"5/8

AVATARM1630CU

L/W 228,5 cm - A/H 198,5 cm - P/D 50 cm
L/W 90" - A/H 78"1/8 - P/D 19"5/8

AVATARM1631CU

ANTE / DOORS



L/W 54,5 cm - A/H 76,5 cm
L/W 21"1/2 - A/H 30"1/8

AVATARM1620CU

L/W 54,5 cm - A/H 76,5 cm
L/W 21"1/2 - A/H 30"1/8

AVATARM1620ES

L/W 54,5 cm - A/H 76,5 cm
L/W 21"1/2 - A/H 30"1/8

AVATARM1632ES

ANTE / DOORS



L/W 54,5 cm - A/H 192,6 cm
L/W 21"1/2 - A/H 75"3/4

AVATARM1628CU

L/W 54,5 cm - A/H 192,6 cm
L/W 21"1/2 - A/H 75"3/4

AVATARM1628ES

L/W 54,5 cm - A/H 115,5 cm
L/W 21"1/2 - A/H 45"1/2

AVATARM1629CU

L/W 54,5 cm - A/H 115,5 cm
L/W 21"1/2 - A/H 45"1/2

AVATARM1629ES

L/W 107,5 cm - A/H 34,5 cm
L/W 42"3/8 - A/H 13"1/2

AVATARM1636CU

L/W 107,5 cm - A/H 34,5 cm
L/W 42"3/8 - A/H 13"1/2

AVATARM1636ES

CASSETTI / DRAWERS



L/W 54,5 cm - A/H 76,5 cm
L/W 21"1/2 - A/H 30"1/8

AVATARM1621CU

L/W 54,5 cm - A/H 76,5 cm
L/W 21"1/2 - A/H 30"1/8

AVATARM1621ES

L/W 54,5 cm - A/H 76,5 cm
L/W 21"1/2 - A/H 30"1/8

AVATARM1622CU

L/W 54,5 cm - A/H 76,5 cm
L/W 21"1/2 - A/H 30"1/8

AVATARM1622ES

L/W 54,5 cm - A/H 76,5 cm
L/W 21"1/2 - A/H 30"1/8

AVATARM1623CU

L/W 54,5 cm - A/H 76,5 cm
L/W 21"1/2 - A/H 30"1/8

AVATARM1623ES

TAVOLINI / COFFEE TABLES



L/W 60 cm - A/H 40,5 cm - P/D 60 cm
L/W 23"5/8 - A/H 16" - P/D 23"5/8

AVATARD1659CU

L/W 60 cm - A/H 40,5 cm - P/D 60 cm
L/W 23"5/8 - A/H 16" - P/D 23"5/8

AVATARD1659ES

L/W 120 cm - A/H 40,5 cm - P/D 60 cm
L/W 47"1/4 - A/H 16" - P/D 23"5/8

AVATARD1660CU

L/W 120 cm - A/H 40,5 cm - P/D 60 cm
L/W 47"1/4 - A/H 16" - P/D 23"5/8

AVATARD1660ES



► CROSSING
DESIGN: LUCA SCACCHETTI





Finiture: essenza tipo palissandro e pelle PX Diana.
Finishings: rosewood type veneer and leather PX Diana.







Finiture: essenza di tipo palissandro e cuoio CF 01.
Finishings: rosewood type veneer and saddle leather CF 01.

Finiture a pagina di destra: essenza tipo palissandro e pelle PX Naomi.
Finishings at opposite page: rosewood type veneer and leather PX Naomi.



Il modello CROSSING è disponibile in un numero limitato di varianti che impiegano due materiali principali:

- Cuoio o pelle. Il cuoio o la pelle sono sempre applicati a pannelli di nobilitato nero di spessore variabile a seconda dell'utilizzo.
 - Essenza di legno tipo palissandro impiallacciata a pannelli di particelle di legno di spessore variabile a seconda dell'utilizzo. Non è possibile utilizzare altre essenze in collezione.
- I piani delle scrivanie, dei tavoli riunione e dei tavolini bassi sono realizzati con pannello di spessore 30 mm completamente rivestito in cuoio o pelle oppure impiallacciato. Sotto ai piani sono applicate delle barre raddrizzanti.

Le gambe e i supporti laterali di appoggio alle cassettiere sono realizzati accoppiando 3 diversi pannelli di particelle di legno con uno spessore totale di 8 cm ed hanno i due bordi verticali smusati lungo il lato interno. Nella loro parte superiore è fissata una piastra di alluminio per consentire un fissaggio più stabile ai piani. Sia la gamba che il supporto laterale sono poi completamente rivestiti in cuoio o pelle.

Il pannello di cortesia è realizzato con un pannello di spessore 20 mm, rivestito in cuoio o pelle oppure impiallacciato.

La gamba può essere sostituita nella sua funzione di sostegno del piano da un mobile cassettiere o da un mobile allungo fissi su cui poggiano i sostegni.

La cassettiere su ruote, quella fissa ed il mobile allungo sono disponibili solo impiallacciati e sono dotati di una finitura con taglio dei pannelli a 45°; i cassetti e le ante con taglio a 45° sono disponibili solo impiallacciati.

È disponibile anche un allungo costituito da un piano realizzato esattamente come il piano della scrivania; questo è fissato da un lato alla scrivania tramite una piastra mentre dall'altro lato si appoggia a una gamba simile a quella della scrivania.

Il mobile basso è disponibile solo a 4 vani con 4 ante oppure con due ante laterali e 3 grandi cassetti centrali solo con finitura impiallacciata. Il mobile così come i cassetti e le ante hanno un taglio dei pannelli a 45°.

Le maniglie sono costituite da una scanalatura realizzata all'interno del pannello, tramite una fresatura effettuata su un inserto in legno massello inserito nel pannello prima di effettuare l'impiallacciatura.

Il mobile può essere dotato anche di un top supplementare con fianchi sempre rivestiti in cuoio o pelle ed il piano in cuoio, pelle o impiallacciato.

The CROSSING model is available in a limited number of combinations that use two kind of materials:

- Saddle leather or leather. The saddle leather and leather are always applied to black melamine coated panels, of various thickness, in accordance with the use.
- Similar rosewood veneered to particleboard panels, of variable thickness, in accordance with the use. This is the only wood available for the model.

The tops of the desks of the conference tables and of the low coffee tables are made with a 30 mm thickness top covered in saddle leather or leather, or veneered. Under the tops there are reinforcement steel bars.

The legs and the side support to the pedestal are made pairing 3 different particleboard panels with a total thickness of 8 cm, and have the vertical edges rounded on the internal side. On the upper part an aluminum sheet is fixed to the leg or to the support in order to give a stronger stability to the top. Both the leg and the side support are completely covered in saddle leather or leather.

The modesty panel is produced with a particleboard panel 20 mm thickness veneered or covered in saddle leather or leather.

The leg, in its function of supporting the top, can be replaced with a pedestal cabinet or with a return sideboard cabinet which leans on a support.

The fixed pedestal as well as the pedestal on casters and the fixed return sideboard cabinet are available only veneered and are made with a special finishing details of the panels cut at 45°; the drawers and the doors always with a cut at 45° are also available just veneered.

It is available also a return composed by a top veneered fixed to the top of the desk with a metal sheet underneath and on the other side fixed to a leg similar to the one of the desk.

The low cabinet is available just in one dimension with 4 units, with 4 doors or with two side doors and 3 big central drawers; all of them are available just veneered. The cabinet as well as doors and drawers has a special finishing details of cut at 45°. The handles are represented by a groove into the door or the drawer, made through a milling into an inlay of solid wood inserted into the particleboard panel before veneering it.

The low cabinet can have also an additional top with sides always covered in saddle leather or leather and with the central element veneered or covered in saddle leather or leather.

PIANI SCRIVANIE / TOP OF DESKS

L/W 160 cm - A/H 3 cm - P/D 90 cm L/W 63" - A/H 1"1/4 - P/D 35"1/2	L/W 160 cm - A/H 3 cm - P/D 90 cm L/W 63" - A/H 1"1/4 - P/D 35"1/2	L/W 180 cm - A/H 3 cm - P/D 90 cm L/W 70"7/8 - A/H 1"1/4 - P/D 35"1/2	L/W 180 cm - A/H 3 cm - P/D 90 cm L/W 70"7/8 - A/H 1"1/4 - P/D 35"1/2
CROSSID1500CU	CROSSID1500ES	CROSSID1501CU	CROSSID1501ES
L/W 200 cm - A/H 3 cm - P/D 90 cm L/W 78"3/4 - A/H 1"1/4 - P/D 35"1/2	L/W 200 cm - A/H 3 cm - P/D 90 cm L/W 78"3/4 - A/H 1"1/4 - P/D 35"1/2		
CROSSID1502CU	CROSSID1502ES		

GAMBE PER PIANI DI SCRIVANIA / LEGS FOR TOP OF THE DESK

L/W 20 cm - A/H 74 cm - P/D 90 cm L/W 7"7/8 - A/H 29"1/8 - P/D 35"1/2	L/W 20 cm - A/H 23 cm - P/D 90 cm L/W 7"7/8 - A/H 9" - P/D 35"1/2	L/W 57 cm - A/H 58 cm - P/D 90 cm L/W 22"1/2 - A/H 22"7/8 - P/D 35"1/2	L/W 43 cm - A/H 61 cm - P/D 56 cm L/W 16"7/8 - A/H 24" - P/D 22"
CROSSID1503CU	CROSSID1504CU	CROSSID1505ES	CROSSID1515ES

MOBILI ALLUNGO / RETURN CABINETS

L/W 180 cm - A/H 58 cm - P/D 50,3 cm L/W 70"7/8 - A/H 22"7/8 - P/D 19"3/4	L/W 180 cm - A/H 58 cm - P/D 50,3 cm L/W 70"7/8 - A/H 22"7/8 - P/D 19"3/4	L/W 90 cm - A/H 74 cm - P/D 50 cm L/W 35"1/2 - A/H 29"1/8 - P/D 19"5/8	L/W 90 cm - A/H 74 cm - P/D 50 cm L/W 35"1/2 - A/H 29"1/8 - P/D 19"5/8
CROSSIM1506ES	CROSSIM1507ES	CROSSID1508CU	CROSSID1508ES

ALLUNGO / RETURN

L/W 90 cm - A/H 74 cm - P/D 50 cm L/W 35"1/2 - A/H 29"1/8 - P/D 19"5/8	L/W 90 cm - A/H 74 cm - P/D 50 cm L/W 35"1/2 - A/H 29"1/8 - P/D 19"5/8
CROSSID1508CU	CROSSID1508ES

PANNELLI DI CORTESIA / MODESTY PANEL

L/W 132 cm - A/H 54 cm - P/D 2 cm L/W 52" - A/H 21"1/4 - P/D 3/4"	L/W 152 cm - A/H 54 cm - P/D 2 cm L/W 59"7/8 - A/H 21"1/4 - P/D 3/4"	L/W 172 cm - A/H 54 cm - P/D 2 cm L/W 67"3/4 - A/H 21"1/4 - P/D 3/4"			
CROSSID1509CU	CROSSID1509ES	CROSSID1510CU	CROSSID1510ES	CROSSID1511CU	CROSSID1511ES
L/W 184 cm - A/H 54 cm - P/D 2 cm L/W 72"1/2 - A/H 21"1/4 - P/D 3/4"	L/W 204 cm - A/H 54 cm - P/D 2 cm L/W 80"3/8 - A/H 21"1/4 - P/D 3/4"			L/W 224 cm - A/H 54 cm - P/D 2 cm L/W 88"1/4 - A/H 21"1/4 - P/D 3/4"	
CROSSID1512CU	CROSSID1512ES	CROSSID1513CU	CROSSID1513ES	CROSSID1514CU	CROSSID1514ES

TAVOLI RIUNIONE / CONFERENCE TABLES

L/W 320 cm - A/H 74 cm - P/D 120 cm L/W 126" - A/H 29"1/8 - P/D 47"1/4	L/W 320 cm - A/H 74 cm - P/D 120 cm L/W 126" - A/H 29"1/8 - P/D 47"1/4
CROSSID1516CU	CROSSID1516ES

L/W 140 cm - A/H 74 cm - P/D 140 cm L/W 55"1/8 - A/H 29"1/8 - P/D 55"1/8	L/W 140 cm - A/H 74 cm - P/D 140 cm L/W 55"1/8 - A/H 29"1/8 - P/D 55"1/8	L/W 100 cm - A/H 74 cm - P/D 100 cm L/W 39"3/8 - A/H 29"1/8 - P/D 39"3/8	L/W 100 cm - A/H 74 cm - P/D 100 cm L/W 39"3/8 - A/H 29"1/8 - P/D 39"3/8
CROSSID1517CU	CROSSID1517ES	CROSSID1518CU	CROSSID1518ES

MOBILI BASSI / LOW CABINETS

L/W 220 cm - A/H 74 cm - P/D 50 cm L/W 86"5/8 - A/H 29"1/8 - P/D 19"5/8	L/W 220 cm - A/H 74 cm - P/D 50 cm L/W 86"5/8 - A/H 29"1/8 - P/D 19"5/8
CROSSIM1520ES	CROSSIM1521ES

TOP PER MOBILI BASSI / TOP FOR LOW CABINETS

L/W 226 cm - A/H 23 cm - P/D 50 cm L/W 89" - A/H 9" - P/D 19"5/8	L/W 226 cm - A/H 23 cm - P/D 50 cm L/W 89" - A/H 9" - P/D 19"5/8
CROSSIM1522CU	CROSSIM1522ES

TAVOLINI / COFFEE TABLES

L/W 60 cm - A/H 43 cm - P/D 60 cm L/W 23"5/8 - A/H 16"7/8 - P/D 23"5/8	L/W 60 cm - A/H 43 cm - P/D 60 cm L/W 23"5/8 - A/H 16"7/8 - P/D 23"5/8	L/W 120 cm - A/H 43 cm - P/D 60 cm L/W 47"1/4 - A/H 16"7/8 - P/D 23"5/8	L/W 120 cm - A/H 43 cm - P/D 60 cm L/W 47"1/4 - A/H 16"7/8 - P/D 23"5/8
CROSSID1523CU	CROSSID1523ES	CROSSID1524CU	CROSSID1524ES



▶ DE SYMETRIA
DESIGN: LUCA SCACCHETTI





Finiture: eucalipto e pelle PX Flipper.
Finishings: eucalyptus wood and leather PX Flipper.





Finiture: scrivania ed allungo in cuoio CF 04 e cristallo laccato colore RAL 1019. Poltrone con retro laccato colore RAL 1019 e fronte in pelle PX Woodstock.
Finishings: desk and sideboard in saddle leather CF 04 and glass varnished in colour RAL 1019. Armchairs with back lacquered colour RAL 1019 and front in leather PX Woodstock.







Finiture: essenza tipo ebano e pelle PA Kandinsky.
Finishings: ebony type veneer and leather PA Kandinsky.











TAVOLI RIUNIONE / CONFERENCE TABLES



L/W 140 cm - A/H 3,5 cm - P/D 140 cm
L/W 55"1/8 - A/H 1"3/8 - P/D 55"1/8

L/W 140 cm - A/H 3,5 cm - P/D 140 cm
L/W 55"1/8 - A/H 1"3/8 - P/D 55"1/8

L/W 140 cm - A/H 1,5 cm - P/D 140 cm
L/W 55"1/8 - A/H 3/8" - P/D 55"1/8

DESYMED1360CC
DESYMED1360PX

DESYMED1360LA

DESYMED1360VV
DESYMED1360EX

MOBILI ALLUNGO / SIDEBOARD



L/W 200 cm - A/H 60 cm - P/D 65 cm
L/W 78"3/4 - A/H 23"5/8 - P/D 25"5/8

L/W 200 cm - A/H 60 cm - P/D 65 cm
L/W 78"3/4 - A/H 23"5/8 - P/D 25"5/8

L/W 200 cm - A/H 60 cm - P/D 65 cm
L/W 78"3/4 - A/H 23"5/8 - P/D 25"5/8

DESYMEM1330CC
DESYMEM1330PX

DESYMEM1331CC
DESYMEM1331PX

DESYMEM1331LA

PANNELLI PER MOBILI ALLUNGO / PANELS FOR SIDEBOARD



L/W 106 cm - A/H 56 cm
L/W 41"3/4 - A/H 22"

L/W 106 cm - A/H 56 cm
L/W 41"3/4 - A/H 22"

L/W 106 cm - A/H 56 cm
L/W 41"3/4 - A/H 22"

DESYMED1332CC
DESYMED1332PX

DESYMED1332LA

DESYMED1332VV

CASSETTI PER MOBILI ALLUNGO / DRAWERS FOR SIDEBOARD



L/W 55 cm - A/H 56 cm
L/W 21"5/8 - A/H 22"

L/W 55 cm - A/H 56 cm
L/W 21"5/8 - A/H 22"

L/W 55 cm - A/H 56 cm
L/W 21"5/8 - A/H 22"

L/W 55 cm - A/H 56 cm
L/W 21"5/8 - A/H 22"

DESYMED1333CC
DESYMED1333PX

DESYMED1333LA

DESYMED1334CC
DESYMED1334PX

DESYMED1334LA

PANNELLI E ANTE PER MOBILI ALLUNGO / PANELS AND DOORS FOR SIDEBOARD



L/W 187 cm - A/H 56 cm
L/W 73"5/8 - A/H 22"

L/W 187 cm - A/H 56 cm
L/W 73"5/8 - A/H 22"

L/W 187 cm - A/H 56 cm
L/W 73"5/8 - A/H 22"

DESYMED1335CC
DESYMED1335PX

DESYMED1335LA

DESYMED1335VV

CASSETTIERE FISSE / FIXED PEDESTAL

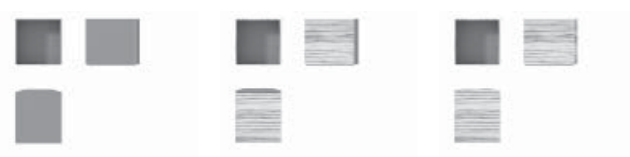

L/W 60 cm - A/H 60 cm - P/D 70 cm
L/W 23"5/8 - A/H 23"5/8 - P/D 27"1/2

DESYMEM1322CC
DESYMEM1322PX

DESYMEM1323CC
DESYMEM1323PX

DESYMEM1323LA

CASSETTI / DRAWERS



L/W 55 cm - A/H 57 cm
L/W 21"5/8 - A/H 22"1/2

DESYMEM1324CC
DESYMEM1324PX

DESYMEM1324LA

L/W 55 cm - A/H 57 cm
L/W 21"5/8 - A/H 22"1/2

DESYMEM1325CC
DESYMEM1325PX

DESYMEM1325LA

CASSETTIERE SU RUOTE / PEDESTAL ON CASTERS



L/W 43 cm - A/H 62 cm - P/D 58 cm
L/W 16"7/8 - A/H 24"3/8 - P/D 22"7/8

L/W 43 cm - A/H 62 cm - P/D 58 cm
L/W 16"7/8 - A/H 24"3/8 - P/D 22"7/8

DESYMEM1326CC
DESYMEM1326PX

DESYMEM1327CC
DESYMEM1327PX

DESYMEM1328CC
DESYMEM1328PX

DESYMEM1329CC
DESYMEM1329PX

MOBILI BASSI / LOW CABINETS



L/W 122 cm - A/H 79 cm - P/D 50 cm
L/W 48" - A/H 31"1/8 - P/D 19"5/8

L/W 122 cm - A/H 79 cm - P/D 50 cm
L/W 48" - A/H 31"1/8 - P/D 19"5/8

L/W 122 cm - A/H 79 cm - P/D 50 cm
L/W 48" - A/H 31"1/8 - P/D 19"5/8

DESYMEM1336CC
DESYMEM1336PX

DESYMEM1337CC
DESYMEM1337PX

DESYMEM1337LA



L/W 176 cm - A/H 79 cm - P/D 50 cm
L/W 69"1/4 - A/H 31"1/8 - P/D 19"5/8

L/W 176 cm - A/H 79 cm - P/D 50 cm
L/W 69"1/4 - A/H 31"1/8 - P/D 19"5/8

L/W 176 cm - A/H 79 cm - P/D 50 cm
L/W 69"1/4 - A/H 31"1/8 - P/D 19"5/8

DESYMEM1338CC
DESYMEM1338PX

DESYMEM1339CC
DESYMEM1339PX

DESYMEM1339LA



L/W 232 cm - A/H 79 cm - P/D 50 cm
L/W 91"3/8 - A/H 31"1/8 - P/D 19"5/8

L/W 232 cm - A/H 79 cm - P/D 50 cm
L/W 91"3/8 - A/H 31"1/8 - P/D 19"5/8

L/W 232 cm - A/H 79 cm - P/D 50 cm
L/W 91"3/8 - A/H 31"1/8 - P/D 19"5/8

DESYMEM1340CC
DESYMEM1340PX

DESYMEM1341CC
DESYMEM1341PX

DESYMEM1341LA



L/W 286 cm - A/H 79 cm - P/D 50 cm
L/W 112"5/8 - A/H 31"1/8 - P/D 19"5/8

L/W 286 cm - A/H 79 cm - P/D 50 cm
L/W 112"5/8 - A/H 31"1/8 - P/D 19"5/8

L/W 286 cm - A/H 79 cm - P/D 50 cm
L/W 112"5/8 - A/H 31"1/8 - P/D 19"5/8

DESYMEM1342CC
DESYMEM1342PX

DESYMEM1343CC
DESYMEM1343PX

DESYMEM1343LA

MOBILI ALTI / HIGH CABINETS



L/W 124 cm - A/H 183 cm - P/D 50 cm
L/W 48"3/4 - A/H 72" - P/D 19"5/8

DESYMEM1351CC
DESYMEM1351PX

L/W 124 cm - A/H 183 cm - P/D 50 cm
L/W 48"3/4 - A/H 72" - P/D 19"5/8

DESYMEM1352CC
DESYMEM1352PX

L/W 124 cm - A/H 183 cm - P/D 50 cm
L/W 48"3/4 - A/H 72" - P/D 19"5/8

DESYMEM1352LA

MOBILI ALTI / HIGH CABINETS



L/W 180 cm - A/H 183 cm - P/D 50 cm
L/W 70"7/8 - A/H 72" - P/D 19"5/8

DESYMEM1353CC
DESYMEM1353PX



L/W 180 cm - A/H 183 cm - P/D 50 cm
L/W 70"7/8 - A/H 72" - P/D 19"5/8

DESYMEM1354CC
DESYMEM1354PX

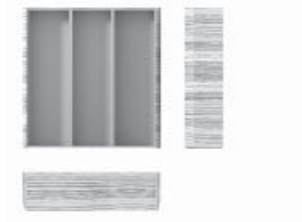

L/W 180 cm - A/H 183 cm - P/D 50 cm
L/W 70"7/8 - A/H 72" - P/D 19"5/8

DESYMEM1354LA



L/W 236 cm - A/H 183 cm - P/D 50 cm
L/W 92"7/8 - A/H 72" - P/D 19"5/8

DESYMEM1355CC
DESYMEM1355PX

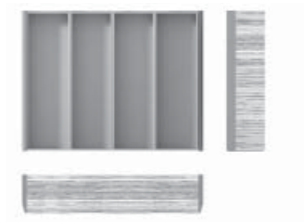

L/W 236 cm - A/H 183 cm - P/D 50 cm
L/W 92"7/8 - A/H 72" - P/D 19"5/8

DESYMEM1356CC
DESYMEM1356PX

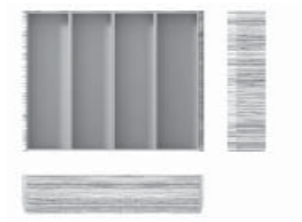

L/W 236 cm - A/H 183 cm - P/D 50 cm
L/W 92"7/8 - A/H 72" - P/D 19"5/8

DESYMEM1356LA

ANTE / DOORS



L/W 54 cm - A/H 76,5 cm
L/W 21"1/4 - A/H 30"1/8

DESYMEM1346CC
DESYMEM1346PX



L/W 54 cm - A/H 76,5 cm
L/W 21"1/4 - A/H 30"1/8

DESYMEM1346LA



L/W 54 cm - A/H 76,5 cm
L/W 21"1/4 - A/H 30"1/8

DESYMEM1346VV



L/W 54 cm - A/H 179 cm
L/W 21"1/4 - A/H 70"1/2

DESYMEM1357CC
DESYMEM1357PX



L/W 54 cm - A/H 179 cm
L/W 21"1/4 - A/H 70"1/2

DESYMEM1357LA



L/W 54 cm - A/H 179 cm
L/W 21"1/4 - A/H 70"1/2

DESYMEM1357VV

CASSETTI / DRAWERS



L/W 54 cm - A/H 76,5 cm
L/W 21"1/4 - A/H 30"1/8

DESYMEM1348CC
DESYMEM1348PX



L/W 54 cm - A/H 76,5 cm
L/W 21"1/4 - A/H 30"1/8

DESYMEM1348LA



L/W 54 cm - A/H 76,5 cm
L/W 21"1/4 - A/H 30"1/8

DESYMEM1349CC
DESYMEM1349PX



L/W 54 cm - A/H 76,5 cm
L/W 21"1/4 - A/H 30"1/8

DESYMEM1349LA



L/W 54 cm - A/H 76,5 cm
L/W 21"1/4 - A/H 30"1/8

DESYMEM1350CC
DESYMEM1350PX



L/W 54 cm - A/H 76,5 cm
L/W 21"1/4 - A/H 30"1/8

DESYMEM1350LA



L/W 54 cm - A/H 28 cm
L/W 21"1/4 - A/H 11"

DESYMEM1358CC
DESYMEM1358PX



L/W 54 cm - A/H 28 cm
L/W 21"1/4 - A/H 11"

DESYMEM1358LA

PIANI TAVOLINI / LOW TABLES



L/W 100 cm - A/H 15 cm - P/D 100 cm
L/W 39"3/8 - A/H 5"7/8 - P/D 39"3/8

DESYMED1364CC
DESYMED1364PX



L/W 100 cm - A/H 15 cm - P/D 100 cm
L/W 39"3/8 - A/H 5"7/8 - P/D 39"3/8

DESYMED1364LA



L/W 100 cm - A/H 15 cm - P/D 100 cm
L/W 39"3/8 - A/H 5"7/8 - P/D 39"3/8

DESYMED1364VV
DESYMED1364EX

GAMBE TAVOLINI / LEGS FOR LOW TABLES



L/W 25 cm - A/H 28 cm - P/D 25 cm
L/W 9"7/8 - A/H 11" - P/D 9"7/8

DESYMED1365CC
DESYMED1365PX



L/W 25 cm - A/H 28 cm - P/D 25 cm
L/W 9"7/8 - A/H 11" - P/D 9"7/8

DESYMED1365LA

RECEPTION / RECEPTION



L/W 250 cm - A/H 104 cm - P/D 81 cm
L/W 98"1/2" - A/H 41" - P/D 31"7/8

DESYMER1366CC
DESYMER1366PX



L/W 250 cm - A/H 104 cm - P/D 81 cm
L/W 98"1/2" - A/H 41" - P/D 31"7/8

DESYMER1366LA

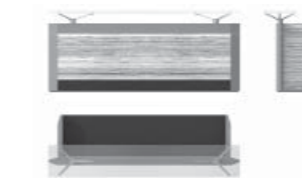

L/W 250 cm - A/H 104 cm - P/D 81 cm
L/W 98"1/2" - A/H 41" - P/D 31"7/8

DESYMER1367CC
DESYMER1367PX

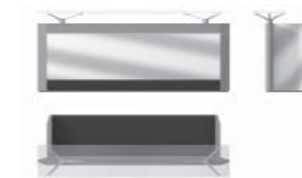

L/W 250 cm - A/H 104 cm - P/D 81 cm
L/W 98"1/2" - A/H 41" - P/D 31"7/8

DESYMER1368CC
DESYMER1368PX

BOISERIE / WALL PANELLING

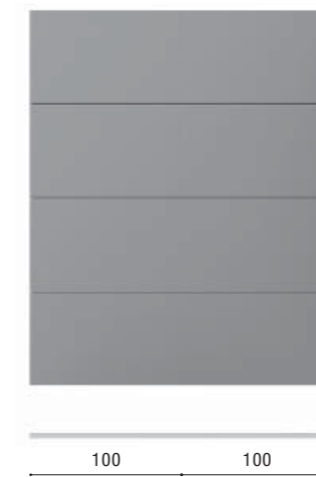

DESYMEB1370CC
DESYMEB1370PX

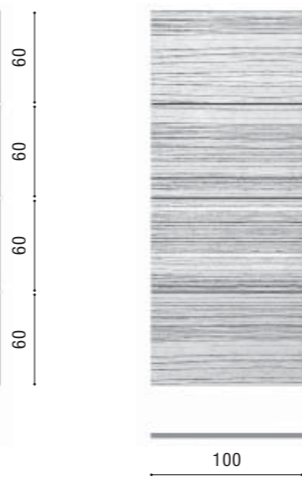

DESYMEB1370LA

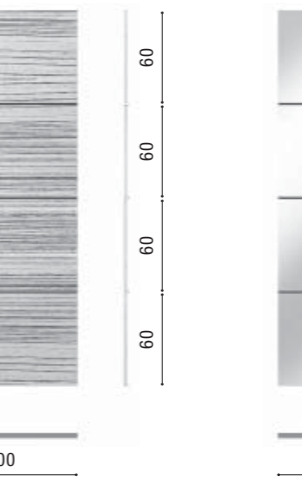

DESYMEB1370VV

RIVESTIMENTO / BOISERIE



L/W 99 cm - A/H 1,2 cm - P/D 26 cm
L/W 39" - A/H 1/2" - P/D 10"1/4

DESYMEB1371CC
DESYMEB1371PX



L/W 99 cm - A/H 1,2 cm - P/D 26 cm
L/W 39" - A/H 1/2" - P/D 10"1/4

DESYMEB1371LA



L/W 99 cm - A/H 1,2 cm - P/D 26 cm
L/W 39" - A/H 1/2" - P/D 10"1/4

DESYMEB1371EX



BLADE

DESIGN: MATTEO NUNZIATI



Finiture: melaminico rovere bianco e rovere grigio. Cuoio CF 01.
Finishings: white oak and grey oak melamine. Saddle leather CF 01.









Finiture: essenza tipo rovere moro e cuoio CF 04. Poltrone in pelle PF 4016.
Finishings: dark brown oak type wood and saddle leather CF 04. Armchairs in leather PF 4016.



Le scrivanie possono essere dotate di scatola per cablaggi dati/elettrici con pannellino di copertura a filo del piano.
Desks can be equipped with a data/electrical wiring box with a flush cover panel.



TOP SUPPLEMENTARE / ADDITIONAL TOP



L/W 60 cm - A/H 7 cm - P/D 70 cm
L/W 23"5/8 - A/H 2"3/4 - P/D 27"1/2

BLADE0M1448CC BLADE0M1448ES BLADE0M1448NO

ALLUNGO / RETURN



L/W 76 cm - A/H 74 cm - P/D 60 cm
L/W 29"7/8 - A/H 29"1/8 - P/D 23"5/8

BLADE0M1443CC BLADE0M1443ES BLADE0M1443NO

PANNELLI DI CORTESIA / MODESTY PANEL



L/W 112 cm - A/H 67 cm - P/D 2 cm
L/W 45" - A/H 26"3/8 - P/D 3/4"

BLADE0D1418CC BLADE0D1418ES BLADE0D1418NO



L/W 154 cm - A/H 67 cm - P/D 2 cm
L/W 60"5/8 - A/H 26"3/8 - P/D 3/4"

BLADE0D1419CC BLADE0D1419ES BLADE0D1419NO



L/W 132 cm - A/H 67 cm - P/D 2 cm
L/W 52" - A/H 26"3/8 - P/D 3/4"

BLADE0D1420CC BLADE0D1420ES BLADE0D1420NO



L/W 174 cm - A/H 67 cm - P/D 2 cm
L/W 68"1/2 - A/H 26"3/8 - P/D 3/4"

BLADE0D1421CC BLADE0D1421ES BLADE0D1421NO



L/W 152 cm - A/H 67 cm - P/D 2 cm
L/W 59"7/8 - A/H 26"3/8 - P/D 3/4"

BLADE0D1422CC BLADE0D1422ES BLADE0D1422NO



L/W 194 cm - A/H 67 cm - P/D 2 cm
L/W 76"3/8 - A/H 26"3/8 - P/D 3/4"

BLADE0D1423CC BLADE0D1423ES BLADE0D1423NO



L/W 172 cm - A/H 67 cm - P/D 2 cm
L/W 67"3/4 - A/H 26"3/8 - P/D 3/4"

BLADE0D1424CC BLADE0D1424ES BLADE0D1424NO



L/W 214 cm - A/H 67 cm - P/D 2 cm
L/W 84"1/4 - A/H 26"3/8 - P/D 3/4"

BLADE0D1425CC BLADE0D1425ES BLADE0D1425NO



L/W 192 cm - A/H 67 cm - P/D 2 cm
L/W 75"5/8 - A/H 26"3/8 - P/D 3/4"

BLADE0D1426CC BLADE0D1426ES BLADE0D1426NO



L/W 234 cm - A/H 67 cm - P/D 2 cm
L/W 92"1/8 - A/H 26"3/8 - P/D 3/4"

BLADE0D1427CC BLADE0D1427ES BLADE0D1427NO

CASSETTIERE SU RUOTE / PEDESTAL ON CASTERS



L/W 43 cm - A/H 61 cm - P/D 56 cm
L/W 16"7/8 - A/H 24" - P/D 22"

BLADE0M1440CC BLADE0M1440ES BLADE0M1440NO

CASSETTI / DRAWERS



L/W 50 cm - A/H 42 cm
L/W 19"5/8 - A/H 16"1/2

BLADE0M1441CC BLADE0M1441ES BLADE0M1441NO



L/W 50 cm - A/H 42 cm
L/W 19"5/8 - A/H 16"1/2

BLADE0M1442CC BLADE0M1442ES BLADE0M1442NO

SCHEMI DIVISORI / FRONTAL SCREEN



L/W 112 cm - A/H 37 cm - P/D 2 cm
L/W 44"1/8 - A/H 14"1/2 - P/D 3/4"

BLADE0D1464NO BLADE0D1464TE



L/W 132 cm - A/H 37 cm - P/D 2 cm
L/W 52" - A/H 14"1/2 - P/D 3/4"

BLADE0D1465NO BLADE0D1465TE



L/W 152 cm - A/H 37 cm - P/D 2 cm
L/W 59"7/8 - A/H 14"1/2 - P/D 3/4"

BLADE0D1466NO BLADE0D1466TE



L/W 172 cm - A/H 37 cm - P/D 2 cm
L/W 67"3/4 - A/H 14"1/2 - P/D 3/4"

BLADE0D1467NO BLADE0D1467TE



L/W 192 cm - A/H 37 cm - P/D 2 cm
L/W 75"5/8 - A/H 14"1/2 - P/D 3/4"

BLADE0D1468NO BLADE0D1468TE

TAVOLI RIUNIONE / CONFERENCE TABLES



L/W 280 cm - A/H 74 cm - P/D 110 cm
L/W 110"1/4 - A/H 29"1/8 - P/D 43"1/4

BLADE0D1413CC



L/W 280 cm - A/H 74 cm - P/D 110 cm
L/W 110"1/4 - A/H 29"1/8 - P/D 43"1/4

BLADE0D1413ES



L/W 280 cm - A/H 74 cm - P/D 110 cm
L/W 110"1/4 - A/H 29"1/8 - P/D 43"1/4

BLADE0D1413NO



L/W 350 cm - A/H 74 cm - P/D 110 cm
L/W 137"3/4 - A/H 29"1/8 - P/D 43"1/4

BLADE0D1414CC



L/W 350 cm - A/H 74 cm - P/D 110 cm
L/W 137"3/4 - A/H 29"1/8 - P/D 43"1/4

BLADE0D1414ES



L/W 350 cm - A/H 74 cm - P/D 110 cm
L/W 137"3/4 - A/H 29"1/8 - P/D 43"1/4

BLADE0D1414NO



L/W 130 cm - A/H 74 cm - P/D 130 cm
L/W 51"1/4 - A/H 29"1/8 - P/D 51"1/4

BLADE0D1416CC



L/W 130 cm - A/H 74 cm - P/D 130 cm
L/W 51"1/4 - A/H 29"1/8 - P/D 51"1/4

BLADE0D1416ES



L/W 130 cm - A/H 74 cm - P/D 130 cm
L/W 51"1/4 - A/H 29"1/8 - P/D 51"1/4

BLADE0D1416NO



L/W 160 cm - A/H 74 cm - P/D 160 cm
L/W 63" - A/H 29"1/8 - P/D 63"

BLADE0D1415CC



L/W 160 cm - A/H 74 cm - P/D 160 cm
L/W 63" - A/H 29"1/8 - P/D 63"

BLADE0D1415ES



L/W 160 cm - A/H 74 cm - P/D 160 cm
L/W 63" - A/H 29"1/8 - P/D 63"

BLADE0D1415NO



L/W 175,5 cm - A/H 74 cm - P/D 175,5 cm
L/W 69"1/8 - A/H 29"1/8 - P/D 69"1/8

BLADE0D1417CC



L/W 175,5 cm - A/H 74 cm - P/D 175,5 cm
L/W 69"1/8 - A/H 29"1/8 - P/D 69"1/8

BLADE0D1417ES



L/W 175,5 cm - A/H 74 cm - P/D 175,5 cm
L/W 69"1/8 - A/H 29"1/8 - P/D 69"1/8

BLADE0D1417NO

MOBILI BASSI / LOW CABINETS



L/W 80 cm - A/H 79 cm - P/D 50 cm
L/W 31"1/2 - A/H 31"1/8 - P/D 19"5/8

BLADE0M1458CC BLADE0M1458ES BLADE0M1458NO

L/W 110 cm - A/H 79 cm - P/D 50 cm
L/W 43"1/4 - A/H 31"1/8 - P/D 19"5/8

BLADE0M1449CC BLADE0M1449ES BLADE0M1449NO



L/W 164 cm - A/H 79 cm - P/D 50 cm
L/W 64"1/2 - A/H 31"1/8 - P/D 19"5/8

BLADE0M1450CC BLADE0M1450ES BLADE0M1450NO

MOBILI ALTI / HIGH CABINETS



L/W 56 cm - A/H 154 cm - P/D 50 cm
L/W 22" - A/H 60"5/8 - P/D 19"5/8

BLADE0M1452CC BLADE0M1452ES BLADE0M1452NO

L/W 56 cm - A/H 154 cm - P/D 50 cm
L/W 22" - A/H 60"5/8 - P/D 19"5/8

BLADE0M1451NO BLADE0M1459NO BLADE0M1460NO

L/W 80 cm - A/H 154 cm - P/D 50 cm
L/W 31"1/2 - A/H 60"5/8 - P/D 19"5/8

ANTE PER MOBILI / DOORS FOR CABINET



L/W 54 cm - A/H 75,5 cm
L/W 21"1/4 - A/H 29"3/4

BLADE0M1453CC BLADE0M1453ES BLADE0M1453NO

L/W 54 cm - A/H 75,5 cm
L/W 21"1/4 - A/H 29"3/4

L/W 54 cm - A/H 75,5 cm
L/W 21"1/4 - A/H 29"3/4

L/W 54 cm - A/H 150 cm
L/W 21"1/4 - A/H 59"

L/W 54 cm - A/H 150 cm
L/W 21"1/4 - A/H 59"

L/W 54 cm - A/H 150 cm
L/W 21"1/4 - A/H 59"

CASSETTI PER MOBILI / DRAWERS FOR CABINET



L/W 54 cm - A/H 75,5 cm
L/W 21"1/4 - A/H 29"3/4

BLADE0M1454CC BLADE0M1454ES BLADE0M1454NO

L/W 54 cm - A/H 75,5 cm
L/W 21"1/4 - A/H 29"3/4

L/W 54 cm - A/H 75,5 cm
L/W 21"1/4 - A/H 29"3/4

L/W 54 cm - A/H 75,5 cm
L/W 21"1/4 - A/H 29"3/4

L/W 54 cm - A/H 75,5 cm
L/W 21"1/4 - A/H 29"3/4

L/W 54 cm - A/H 75,5 cm
L/W 21"1/4 - A/H 29"3/4

L/W 54 cm - A/H 75,5 cm
L/W 21"1/4 - A/H 29"3/4

BLADE0M1456CC BLADE0M1456ES BLADE0M1456NO

L/W 54 cm - A/H 75,5 cm
L/W 21"1/4 - A/H 29"3/4

L/W 54 cm - A/H 75,5 cm
L/W 21"1/4 - A/H 29"3/4

L/W 79 cm - A/H 75,5 cm
L/W 31"1/8 - A/H 29"3/4

L/W 79 cm - A/H 75,5 cm
L/W 31"1/8 - A/H 29"3/4

L/W 79 cm - A/H 75,5 cm
L/W 31"1/8 - A/H 29"3/4

PANNELLI LATERALI / SIDE PANEL



L/W 2,5 cm - A/H 79 cm - P/D 50 cm
L/W 1" - A/H 31"1/8 - P/D 19"5/8

BLADE0M1462CC BLADE0M1462ES BLADE0M1462NO

L/W 2,5 cm - A/H 154 cm - P/D 50 cm
L/W 1" - A/H 60"5/8 - P/D 19"5/8

BLADE0M1463CC BLADE0M1463ES BLADE0M1463NO

POLTRONE / ARMCHAIRS



L/W 51 cm - A/H 107-113 cm - a/h 42-48 cm - P/D 53 cm
L/W 20"1/8 - A/H 42"1/8-44"1/2 cm - a/h 16"1/2-18"7/8 - P/D 20"7/8

BLADE0POL1470

L/W 51 cm - A/H 91-98 cm - a/h 42-48 cm - P/D 53 cm
L/W 20"1/8 - A/H 35"3/4-38"1/2 cm - a/h 16"1/2-18"7/8 - P/D 20"7/8

BLADE0POL1471



L/W 51 cm - A/H 107-113 cm - a/h 42-48 cm - P/D 53 cm
L/W 20"1/8 - A/H 42"1/8-44"1/2 cm - a/h 16"1/2-18"7/8 - P/D 20"7/8

BLADE0POL1472

L/W 51 cm - A/H 91-98 cm - a/h 42-48 cm - P/D 53 cm
L/W 20"1/8 - A/H 35"3/4-38"1/2 cm - a/h 16"1/2-18"7/8 - P/D 20"7/8

BLADE0POL1473



L/W 51 cm - A/H 110 cm - a/h 48 cm - P/D 53 cm
L/W 20"1/8 - A/H 43"1/4 cm - a/h 18"7/8 - P/D 20"7/8

BLADE0POL1474

L/W 51 cm - A/H 98 cm - a/h 48 cm - P/D 53 cm
L/W 20"1/8 - A/H 38"1/2 cm - a/h 18"7/8 - P/D 20"7/8

BLADE0POL1475



L/W 51 cm - A/H 110 cm - a/h 48 cm - P/D 53 cm
L/W 20"1/8 - A/H 43"1/4 cm - a/h 18"7/8 - P/D 20"7/8

BLADE0POL1476

L/W 51 cm - A/H 98 cm - a/h 48 cm - P/D 53 cm
L/W 20"1/8 - A/H 38"1/2 cm - a/h 18"7/8 - P/D 20"7/8

BLADE0POL1477



L/W 46 cm - A/H 88-98 cm - a/h 46-56 cm - P/D 56,5 cm
L/W 18"1/8 - A/H 34"5/8-38"1/2 cm - a/h 18"1/8"-22 - P/D 21"1/4

BEVERLUFFCUOI

L/W 46 cm - A/H 88-98 cm - a/h 46-56 cm - P/D 56,5 cm
L/W 18"1/8 - A/H 34"5/8-38"1/2 cm - a/h 18"1/8"-22 - P/D 21"1/4

BEVERLUFFIMBO



L/W 46 cm - A/H 88-98 cm - a/h 46-56 cm - P/D 56,5 cm
L/W 18"1/8 - A/H 34"5/8-38"1/2 cm - a/h 18"1/8"-22 - P/D 21"1/4

BEVERLUFFLACC



▶ PASO DOBLE
DESIGN: LUCA SCACCHETTI





Finiture: noce canaletto rigato e cuoio CF 04.
Finishings: striped black walnut wood and saddle leather CF 04.











Finiture: noce canaletto rigato e cuoio CF 05.
Finishings: striped black walnut wood and saddle leather CF 05.







Finiture: noce canaletto rigato e cuoio CF 22.
Finishings: striped black walnut wood and saddle leather CF 22.



PASO DOBLE i piani delle scrivanie sono costituiti da pannelli nobilitati con uno spessore di 30 o 35 mm; il bordo dei 4 lati è smussato a 30°. Il piano può essere rivestito in cuoio completamente oppure lungo i suoi bordi perimetrali; in questo secondo caso nella parte centrale viene fissato un inserto con spessore di 8 mm realizzato con un pannello di particelle di legno impiallacciato con essenza di noce canaletto oppure un inserto in cristallo verniciato nero nella sua faccia inferiore. I sostegni dei piani sono costituiti da due gambe doppie in legno massiccio di noce canaletto lucidate, fresate negli angoli superiori per consentire l'alloggiamento di una piastra a sua volta fissata al piano del tavolo. Questa piastra è costituita da quattro "staffe" in fusione di ghisa sferoidale alle quali è saldata una barra d'acciaio; alla base delle due doppie gambe è fissato un piedino in acciaio che funge anche da distanziale fra le due gambe stesse. Le due doppie gambe sono inoltre collegate fra loro da una barra stabilizzatrice in acciaio la quale fornisce anche un ulteriore sostegno al piano della scrivania. Tutte le parti metalliche descritte e a vista sono verniciate a polveri epossidiche colore nero metallizzato raggrinzante. Le scrivanie possono essere dotate di un pannello di cortesia costituito da pannello nobilitato in finitura noce canaletto con uno spessore di 20 mm con una finitura di cuoio alle estremità oppure completamente rivestiti in cuoio. Gli allunghi hanno un piano di pannello nobilitato nero spessore di 35 mm smussato lungo i 4 lati completamente rivestito in cuoio. Da un lato è fissato alla gamba della scrivania tramite una piastra d'acciaio verniciata; dall'altro ha un sostegno che può essere costituito o da una gamba singola identica alla scrivania oppure da una cassetiera. La cassetiera ha una struttura in pannello nobilitato in finitura noce canaletto spessore di 20 mm con 4 cassetti; il frontale dei cassetti è realizzato in pannello nobilitato finitura noce canaletto rivestito in cuoio oppure in pannello di particelle di legno impiallacciato con essenza di noce canaletto. I tavoli riunione singoli o componibili hanno i piani realizzati con pannello nobilitato nero spessore di 35 mm completamente rivestito in cuoio ed i sostegni uguali a quelli della scrivania. I mobili contenitori sono costruiti in pannello nobilitato con finitura noce canaletto e spessore variabile nei diversi elementi da 16 mm a 30 mm. Nella base di ogni mobile lungo tutto il fronte è inserita una finitura di cuoio. Il top è realizzato in pannello nobilitato in finitura noce canaletto con spessore di 30 mm smussato sul fronte; nel mobile h 96 cm è completamente ricoperto in cuoio mentre in quello h 176 cm è ricoperto in cuoio solo il bordo frontale. Il sostegno è costituito da 4 ruote per le cassette o da 4 piedini in fusione di ghisa sferoidale verniciati a polveri epossidiche colore nero metallizzato raggrinzante con una piccola striscia di cuoio con funzione antigraffio. Per i mobili con 3, 4 e 5 vani vengono posizionati al centro rispettivamente 1 e 2 piedi cilindrici centrali aggiuntivi con le stesse finiture. Le maniglie sono realizzate in trafilato millerighe di alluminio verniciate a polveri epossidiche colore nero metallizzato raggrinzante, rivestite in cuoio nella parte superiore e inserite in un'apposita fresatura dell'anta e del cassetto. I frontali dei cassetti, dei classificatori e delle ante sono in pannello di particelle di legno impiallacciato con essenza di noce canaletto oppure in pannello nobilitato finitura noce canaletto ricoperti in cuoio.

PASO DOBLE the desk tops consist of 30 or 35 mm thick melamine coated panels; the edge of the 4 short sides is bevelled to 30°. The top may be covered either completely in saddle leather or only on the outer edges. In this second case an insert is fixed in the central part; it can be a black walnut veneered particleboard panel or a glass insert painted black underneath. The supports for the top consist of two double legs in solid black walnut wood, milled on the upper edges to allow a metal plate to be housed that is in turn fixed to the top. This plate comprises four spheroidal graphite cast iron "brackets" to which a steel bar is welded; a steel foot is fixed to the end of the two double legs and also acts as spacer between the same two legs. The two double legs are also connected together by a stabilizing steel bar, which also provides a further support for the desk top. All the above mentioned metal parts are wrinkled black epoxy powder varnished. The desks may be fitted with a modesty panel consisting of a 20 mm thick black walnut finish melamine coated panel with a saddle leather detail at the ends or completely covered by saddle leather. The extensions are a 35 mm thickness black melamine coated panel bevelled on all 4 sides and fully covered in leather. This top is fixed on one side to the desk leg by a varnished steel plate; it has a support on the other side, which may be either a single leg identical to the one of the desk or a drawer unit. The drawer unit has a structure in 20 mm thick coated panel with black walnut finish and 4 drawers; the drawer front is in melamine coated panel covered by saddle leather or in particleboard panel veneered with black walnut. The single or modular conference tables have tops made with 35 mm thickness black melamine coated panel fully covered by saddle leather, while the supports are identical to those of the desk. The cabinets are made with black walnut finish melamine coated panel and the thickness of the elements varies from 20 mm to 30 mm. A leather finish is inserted along the whole front at the bottom of each cabinet. The top is made in 30 mm thick melamine coated panel with a black walnut finish, bevelled along the front edge; in the 96 mm high cabinet it is fully covered by saddle leather, while in the 176 mm high cabinet only the front edge is covered by saddle leather. The support for the drawer units consists of 4 casters or 4 feet in spheroidal graphite cast iron wrinkled black epoxy powder varnished and a small strip of leather with an anti-scratch function. The 3, 4 and 5 units cabinet have 1 or 2 extra central cylindrical feet with the same finishes positioned in the centre. The drawn finely ribbed aluminium handles are wrinkled black epoxy powder varnished and covered by saddle leather in the upper part; they are inserted in a special groove in the door and the drawer. The fronts of the drawers, files and doors are in black walnut veneered particleboard panels or in black walnut finish melamine coated panel covered by saddle leather.

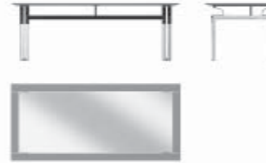

SCRIVANIE / DESKS

		
L/W 200 cm - A/H 74 cm - P/D 100 cm L/W 78"3/4 - A/H 29"1/8 - P/D 39"3/8 PASODDES1000	L/W 200 cm - A/H 74 cm - P/D 100 cm L/W 78"3/4 - A/H 29"1/8 - P/D 39"3/8 PASODDES1001	L/W 200 cm - A/H 74 cm - P/D 100 cm L/W 78"3/4 - A/H 29"1/8 - P/D 39"3/8 PASODDES1002
		
L/W 220 cm - A/H 74 cm - P/D 100 cm L/W 86"5/8 - A/H 29"1/8 - P/D 39"3/8 PASODDES1003	L/W 220 cm - A/H 74 cm - P/D 100 cm L/W 86"5/8 - A/H 29"1/8 - P/D 39"3/8 PASODDES1004	L/W 220 cm - A/H 74 cm - P/D 100 cm L/W 86"5/8 - A/H 29"1/8 - P/D 39"3/8 PASODDES1005



PANNELLI DI CORTESIA / MODESTY PANEL

			
L/W 152 cm - A/H 48 cm - P/D 3 cm L/W 59"7/8 - A/H 18"7/8 - P/D 1"1/4 PASODDES1047	L/W 152 cm - A/H 48 cm - P/D 3 cm L/W 59"7/8 - A/H 18"7/8 - P/D 1"1/4 PASODDES1045	L/W 172,5 cm - A/H 48 cm - P/D 3 cm L/W 67"7/8 - A/H 18"7/8 - P/D 1"1/4 PASODDES1048	L/W 172,5 cm - A/H 48 cm - P/D 3 cm L/W 67"7/8 - A/H 18"7/8 - P/D 1"1/4 PASODDES1046



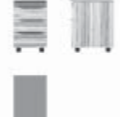

MOBILI ALLUNGO / RETURN CABINETS

		
L/W 121,5 cm - A/H 64,5 cm - P/D 52,5 cm L/W 47"7/8 - A/H 25"3/8 - P/D 20"5/8 PASODMOB1017	L/W 121,5 cm - A/H 64,5 cm - P/D 52,5 cm L/W 47"7/8 - A/H 25"3/8 - P/D 20"5/8 PASODMOB1018	L/W 121,5 cm - A/H 64,5 cm - P/D 52,5 cm L/W 47"7/8 - A/H 25"3/8 - P/D 20"5/8 PASODMOB1019

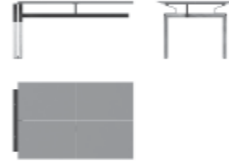

CASSETTIERE SU RUOTE / PEDESTAL ON CASTERS



			
L/W 42,5 cm - A/H 68 cm - P/D 59 cm L/W 16"3/4 - A/H 26"3/4 - P/D 23"1/4 PASODMOB1013	L/W 42,5 cm - A/H 68 cm - P/D 59 cm L/W 16"3/4 - A/H 26"3/4 - P/D 23"1/4 PASODMOB1014	L/W 42,5 cm - A/H 68 cm - P/D 59 cm L/W 16"3/4 - A/H 26"3/4 - P/D 23"1/4 PASODMOB1015	L/W 42,5 cm - A/H 68 cm - P/D 59 cm L/W 16"3/4 - A/H 26"3/4 - P/D 23"1/4 PASODMOB1016

TAVOLI RIUNIONE / CONFERENCE TABLES



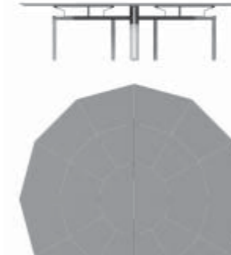
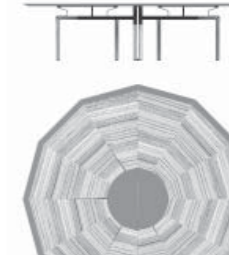

			
L/W 280 cm - A/H 74 cm - P/D 120 cm L/W 110"1/4 - A/H 29"1/8 - P/D 47"1/4 PASODDES1006	L/W 150 cm - A/H 74 cm - P/D 100 cm L/W 59" - A/H 29"1/8 - P/D 39"3/8 PASODDES1007	L/W 220 cm - A/H 74 cm - P/D 100 cm L/W 86"5/8 - A/H 29"1/8 - P/D 39"3/8 PASODDES1008	L/W 220 cm - A/H 74 cm - P/D 100 cm L/W 86"5/8 - A/H 29"1/8 - P/D 39"3/8 PASODDES1009
			
L/W 110 cm - A/H 74 cm - P/D 110 cm L/W 43"1/4 - A/H 29"1/8 - P/D 43"1/4 PASODDES1010		L/W 81,5 cm - A/H 71 cm - P/D 12 cm L/W 32"1/8 - A/H 28" - P/D 4"3/4 PASODDES1012	

TAVOLI RIUNIONE / CONFERENCE TABLES

			
L/W 214 cm - A/H 74 cm - P/D 214 cm L/W 84"1/4 - A/H 29"1/8 - P/D 84"1/4 PASODDES1049	L/W 214 cm - A/H 74 cm - P/D 214 cm L/W 84"1/4 - A/H 29"1/8 - P/D 84"1/4 PASODDES1050	L/W 300 cm - A/H 74 cm - P/D 300 cm L/W 118"1/8 - A/H 29"1/8 - P/D 118"1/8 PASODDES1011	L/W 300 cm - A/H 74 cm - P/D 300 cm L/W 118"1/8 - A/H 29"1/8 - P/D 118"1/8 PASODDES1051

	
L/W 100 cm - A/H 74 cm - P/D 100 cm L/W 39"3/8 - A/H 29"1/8 - P/D 39"3/8 PASODDES1056	L/W 100 cm - A/H 74 cm - P/D 100 cm L/W 39"3/8 - A/H 29"1/8 - P/D 39"3/8 PASODDES1057

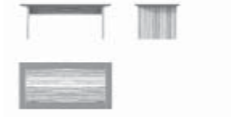
TAVOLINI / SMALL TABLES

			
L/W 120 cm - A/H 45 cm - P/D 60 cm L/W 47"1/4 - A/H 17"3/4 - P/D 23"5/8 PASODDES1052	L/W 60 cm - A/H 45 cm - P/D 60 cm L/W 23"5/8 - A/H 17"3/4 - P/D 23"5/8 PASODDES1053	L/W 120 cm - A/H 45 cm - P/D 60 cm L/W 47"1/4 - A/H 17"3/4 - P/D 23"5/8 PASODDES1054	L/W 60 cm - A/H 45 cm - P/D 60 cm L/W 23"5/8 - A/H 17"3/4 - P/D 23"5/8 PASODDES1055

MOBILI BASSI / LOW CABINETS



L/W 112,5 cm - A/H 95 cm - P/D 53,5 cm
L/W 44"1/4 - A/H 37"3/8 - P/D 21"1/8

PASODOMOB1020



L/W 166,5 cm - A/H 95 cm - P/D 53,5 cm
L/W 65"1/2 - A/H 37"3/8 - P/D 21"1/8

PASODOMOB1021

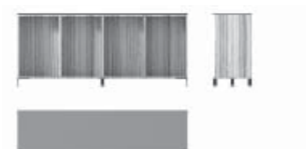

L/W 222 cm - A/H 95 cm - P/D 53,5 cm
L/W 87"3/8 - A/H 37"3/8 - P/D 21"1/8

PASODOMOB1022

CASSETTI / DRAWERS



L/W 55 cm - A/H 79,5 cm
L/W 21"5/8 - A/H 31"1/4

PASODOMOB1023



L/W 55 cm - A/H 79,5 cm
L/W 21"5/8 - A/H 31"1/4

PASODOMOB1024



L/W 55 cm - A/H 79,5 cm
L/W 21"5/8 - A/H 31"1/4

PASODOMOB1025

ANTE / DOORS



L/W 55 cm - A/H 79,5 cm
L/W 21"5/8 - A/H 31"1/4

PASODOMOB1026



L/W 55 cm - A/H 79,5 cm
L/W 21"5/8 - A/H 31"1/4

PASODOMOB1027



L/W 55 cm - A/H 79,5 cm
L/W 21"5/8 - A/H 31"1/4

PASODOMOB1028



L/W 55 cm - A/H 79,5 cm
L/W 21"5/8 - A/H 31"1/4

PASODOMOB1029



L/W 55 cm - A/H 79,5 cm
L/W 21"5/8 - A/H 31"1/4

PASODOMOB1030

MOBILI ALTI / HIGH CABINETS



L/W 112 cm - A/H 175 cm - P/D 53,5 cm
L/W 44"1/8 - A/H 68"7/8 - P/D 21"1/8

PASODOMOB1031



L/W 168 cm - A/H 175 cm - P/D 53,5 cm
L/W 66"1/8 - A/H 68"7/8 - P/D 21"1/8

PASODOMOB1032



L/W 224 cm - A/H 175 cm - P/D 53,5 cm
L/W 88"1/4 - A/H 68"7/8 - P/D 21"1/8

PASODOMOB1033



L/W 280 cm - A/H 175 cm - P/D 53,5 cm
L/W 110 1/4" - A/H 68"7/8 - P/D 21"1/8

PASODOMOB1034

ANTE / DOORS



L/W 55 cm - A/H 159,5 cm
L/W 21"5/8 - A/H 62"3/4

PASODOMOB1035



L/W 55 cm - A/H 159,5 cm
L/W 21"5/8 - A/H 62"3/4

PASODOMOB1036



L/W 55 cm - A/H 159,5 cm
L/W 21"5/8 - A/H 62"3/4

PASODOMOB1037

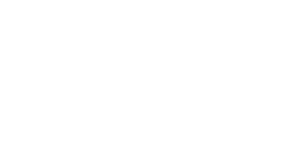

L/W 55 cm - A/H 159,5 cm
L/W 21"5/8 - A/H 62"3/4

PASODOMOB1038

ANTE CON CASSETTI / DOORS WITH DRAWERS



L/W 55 cm - A/H 159,5 cm
L/W 21"5/8 - A/H 62"3/4

PASODOMOB1039



L/W 55 cm - A/H 159,5 cm
L/W 21"5/8 - A/H 62"3/4

PASODOMOB1040



L/W 55 cm - A/H 159,5 cm
L/W 21"5/8 - A/H 62"3/4

PASODOMOB1041



L/W 55 cm - A/H 159,5 cm
L/W 21"5/8 - A/H 62"3/4

PASODOMOB1042



▶ ARES

DESIGN: LUCA SCACCHETTI





Finiture: ebano macassar e cuoio CF 01. Dettagli cromati.
Poltrone in pelle PF 4105.
Finishings: macassar ebony wood and saddle leather CF 01.
Chromed details. Armchairs in leather PF 4105.







Finiture: noce canaletto fiammato e cuoio CF 01. Dettagli verniciati colore RAL 8019.
Finishings: veined black walnut wood and saddle leather CF 01. Details varnished in colour RAL 8019.

ARES è disponibile rivestito in Cuoio (C) oppure con essenza di Ebano (E), Noce (N) o Zebano (Z). Le finiture delle parti in alluminio sono disponibili in cromato lucidato, verniciato silver oppure verniciato ottone opaco.

I piani delle scrivanie e dei tavoli riunione sono costituiti da un top di 30 mm, ed un subtop di 20 mm. entrambi di pannello nobilitato nero per la variante cuoio oppure in pannello di legno di legno per le varianti di essenze di legno. Il top è disponibile in tre tipologie: completamente rivestito in cuoio con bordi in cuoio, rivestito in cuoio con bordi in cuoio e inserto centrale di 8 mm di spessore impiallacciato in essenza oppure completamente impiallacciato in essenza con bordi in essenza. Il bordo del subtop invece è sempre impiallacciato in una delle tre essenze disponibili. Fra il top ed il subtop viene fissato un profilo in alluminio con le tre finiture previste. Sotto ai piani sono fissate quattro barre di acciaio con funzione di stabilità e resistenza.

Le gambe delle scrivanie e del piano allungo sono realizzate in massello di pioppo incamicciato da 5 mm, di MDF e impiallacciate in una delle tre essenze oppure rivestite in cuoio. Alla sommità della stessa troviamo un capitello in alluminio pressofuso con le tre finiture previste, che funge da elemento di appoggio e fissaggio della gamba alla scrivania. Alla base della gamba è fissato un piatto in alluminio pressofuso – disponibile nelle tre finiture – che funge da piedino.

Il pannello di cortesia è costituito da un pannello nobilitato di 20 mm, rivestito completamente in cuoio oppure impiallacciato in una delle tre essenze. Alla base dello stesso è fissato un profilo in alluminio nelle tre finiture, mentre due staffe sempre in alluminio consentono il fissaggio dello stesso al piano.

L'allungo della scrivania è costituito da un piano realizzato esattamente come il piano della scrivania con top e subtop con tutte le possibili varianti per cuoio e essenze. Questo piano è fissato alla scrivania tramite una piastra mentre dall'altro lato si appoggia o a una gamba (identica a quella della scrivania) oppure a un mobile a uno o due vani.

Il mobile contenitore può essere a uno o due vani di larghezza diversa ed ha una struttura in nobilitato nero completamente rivestita in cuoio sia sui fianchi che sul retro. I frontali del mobile – in due misure diverse di larghezza – sono costituiti da ante, cassetti e classificatori realizzati con pannelli di particelle di legno di 20 mm, impiallacciati in una delle tre essenze oppure con pannelli di nobilitato nero rivestiti in cuoio. Le maniglie e i piedini sono in alluminio in una delle tre finiture. È disponibile una cassaforte integrata nel mobile in due diverse misure con combinazione manuale o elettronica.

La cassettera su ruote ha una struttura in nobilitato nero completamente rivestita in cuoio sia sui fianchi che sul retro che sul top. I frontali dei cassetti e dei classificatori sono realizzati con pannelli di particelle di legno di 20 mm, impiallacciati in una delle tre essenze oppure con pannelli di nobilitato nero rivestiti in cuoio. Le maniglie sono in alluminio in una delle tre finiture. I mobili alti e bassi hanno una struttura in nobilitato nero con spessore variabile fra 35 e 18 mm, rivestito in cuoio sui fianchi e lungo le spalle di separazione fra un vano e l'altro. Il top del mobile è un pannello di nobilitato nero di 35 mm, con bordo impiallacciato in una delle tre essenze e rivestito completamente in cuoio per i mobili bassi oppure rivestito in cuoio solo lungo i bordi per i mobili alti. I frontali delle ante dei cassetti e dei classificatori sono realizzati con pannelli di particelle di legno di 20 mm, impiallacciati in una delle tre essenze oppure con pannelli di nobilitato nero rivestiti in cuoio. Le maniglie sono in alluminio in una delle tre finiture.

Le poltrone hanno una unica struttura per seduta, braccioli e schienale basso comune a tutte le poltroncine realizzata in tubolare d'acciaio e rivestita con poliuretano espanso con densità di 50 kg/m³ e poi ancora con vellutino accoppiato. La poltrona direzionale alta e conferenza media sono poi dotate di uno schienale aggiuntivo sempre con struttura in acciaio e rivestimento in poliuretano espanso (50 kg/m³) e vellutino accoppiato. Le poltrone hanno un basamento a 5 razze in alluminio pressofuso in una delle tre finiture disponibili (lucidato o verniciato silver o verniciato ottone opaco) e sono girevoli, regolabili in altezza tramite pistone a gas e dotate di meccanismo basculante. La poltrona a pozzetto è disponibile anche con un basamento a croce in acciaio in una delle tre finiture con pistone con meccanismo di ritorno.

Nella collezione è disponibile anche una lampada da terra con fusto in legno massello di pioppo incamicciato da 5 mm, di MDF e impiallacciato in una delle tre essenze oppure rivestito in cuoio. Le parti metalliche hanno le 3 finiture disponibili e il cristallo è in finitura acidato.

ARES is available covered by saddle leather (C) or in Ebonywood (E) Walnutwood (N) or Zebano wood (Z); the finishes of the aluminium parts are available in chromed polish, silver painted or matte brass painted.

The tops of the desks and the conference tables are composed by a top with thickness mm 30 and by a subtop thickness mm 20, both in black melamine coated panel for the saddle leather version or in particleboard panel for the wood veneered version.

The top is available in three different finishes: completely covered by saddle leather with edges in saddle leather, covered by saddle leather with also saddle leather edges and central veneered inlay thickness mm 8 or completely veneered both top and edges. Whereas the edge of the subtop is always veneered in one of the three wood finishes available. Between the top and the subtop is fixed an aluminium profile with the three provided finishes. Under the tops are fixed four steel bars with the function to give stability and strength.

The legs of the desk and of the extension are made by solid poplar wood covered by mm 5 of MDF and veneered with one of the three wood finishes or covered by saddle leather. On their top there is an aluminium pressure die-cast element with the three available finishes, that acts as support and fixing element of the leg to the desk. On the base of the leg is fixed an aluminium pressure die-cast plate, available in the three finishes, that acts as a foot.

The modesty panel is made by melamine coated mm 20, completely covered by saddle leather or veneered in one of the three wooden finishes. At the base of the same is fixed an aluminium profile in the three finishes, while two stirrups (in aluminium too) permit the fix of the same modesty panel to the top.

The top of the return is produced exactly as the top of the desk, with top and subtop with all the possible versions for saddle leather and woods. This top is fixed to the desk through a plate, while from the other side it is put on a leg (the same as the one on the desk) or to one or two units cabinet.

The cabinet can be with one or two units with a different wide and its frame is made by black melamine coated panel completely covered by saddle leather, on the sides and also on the back. The fronts of the cabinet - in the 2 different dimensions of width - can be doors, drawers and files, produced with particleboard panel of mm 20 veneered in one of the three woods or with black melamine coated panel covered by saddle leather. The handles and the feet are in aluminium in one of the three finishes. It's available a safe, insert into the cabinet, with two different capacities with manual or electronic combination.



The pedestal on casters has a frame in black melamine coated panel, completely covered by saddle leather (on the sides, on the back and on the top too). The fronts of the drawers and the files are made by particleboard panels of mm 20 veneered in one of the three woods or with black melamine coated panels covered by saddle leather. The handles are in aluminium in one of three finishes.

The high and low cabinets have a frame in black melamine coated panel (with a variable thickness from mm 35 and 18 mm), covered by saddle leather on the sides and also on the dividing side panels from one unit and the other. The top of the cabinet is a black melamine coated panel mm 35 with edge veneered in one of the three woods and completely covered by saddle leather for the low cabinets or covered by saddle leather only on the edges for the high cabinets. The fronts of the doors, drawers and files are made by particleboard panels mm 20 veneered in one of the three woods or by black melamine coated panels covered by saddle leather. The handles are in aluminium in one of the three finishes.



The armchair have a unique frame for the seat, the arms and the low back (in common for all the armchairs); it is made by a tubular steel and covered by polyurethane foam with density of 50 kg/m³ and then with bonded plush.

The high executive armchair and the middle height conference armchair are then equipped by an extra back, always with steel frame, covering in polyurethane foam (50kg/m³) and bonded plush. The armchairs have a 5 star swivel base in pressure die-cast aluminium in one of the three finishes available (polished or silver painted or matte brass painted), height adjustable through a gas-piston and are equipped by a tilt mechanism. The conference tub armchair is also available with a cross steel base in one of the three finishes and with a recovery mechanism piston. In the collection is also available a floor lamp with frame in solid poplar wood covered by mm 5 of MDF and veneered with one of the three woods finishes or covered by saddle leather. The metal parts have the three available finishes and the glass have an acid-etched finish.

PIANI SCRIVANIE / TOP OF DESKS

		
L/W 240 cm - A/H 5 cm - P/D 118 cm L/W 94"1/2 - A/H 2" - P/D 46"1/2	L/W 240 cm - A/H 5 cm - P/D 118 cm L/W 94"1/2 - A/H 2" - P/D 46"1/2	L/W 240 cm - A/H 5 cm - P/D 118 cm L/W 94"1/2 - A/H 2" - P/D 46"1/2
ARES00D1202CE ARES00D1202CN ARES00D1202CZ	ARES00D1202EE ARES00D1202NN ARES00D1202ZZ	ARES00D1203EE ARES00D1203NN ARES00D1203ZZ





PIANI DI TAVOLI RIUNIONE / TOP OF CONFERENCE TABLES

		
L/W 318 cm - A/H 5 cm - P/D 118 cm L/W 125"1/4 - A/H 2" - P/D 46"1/2	L/W 318 cm - A/H 5 cm - P/D 118 cm L/W 125"1/4 - A/H 2" - P/D 46"1/2	L/W 318 cm - A/H 5 cm - P/D 118 cm L/W 125"1/4 - A/H 2" - P/D 46"1/2
ARES00D1204CE ARES00D1204CN ARES00D1204CZ	ARES00D1204EE ARES00D1204NN ARES00D1204ZZ	ARES00D1205EE ARES00D1205NN ARES00D1205ZZ



GAMBE PER PIANI SCRIVANIE / LEGS FOR TOP OF DESKS

	
L/W 12,5 cm - A/H 68 cm - P/D 12,5 cm L/W 4"7/8 - A/H 26"3/4 - P/D 4"7/8	L/W 12,5 cm - A/H 68 cm - P/D 12,5 cm L/W 4"7/8 - A/H 26"3/4 - P/D 4"7/8
ARES00D1206CC ARES00D1206EE ARES00D1206NN ARES00D1206ZZ	ARES00D1206CC ARES00D1206EE ARES00D1206NN ARES00D1206ZZ



PIANI DI TAVOLI RIUNIONE E RELATIVE GAMBE / TOP OF CONFERENCE TABLES AND RELATIVE LEGS

			
L/W 100 cm - A/H 5 cm - P/D 100 cm L/W 39"7/8 - A/H 2" - P/D 39"7/8	L/W 100 cm - A/H 5 cm - P/D 100 cm L/W 39"7/8 - A/H 2" - P/D 39"7/8	L/W 60 cm - A/H 68 cm - P/D 60 cm L/W 23"5/8 - A/H 26"3/4 - P/D 23"5/8	L/W 60 cm - A/H 68 cm - P/D 60 cm L/W 23"5/8 - A/H 26"3/4 - P/D 23"5/8
ARES00D1245CE ARES00D1245CN ARES00D1245CZ	ARES00D1245EE ARES00D1245NN ARES00D1245ZZ	ARES00D1246CC	ARES00D1246EE ARES00D1246NN ARES00D1246ZZ

CASSETTIERE SU RUOTE / PEDESTAL ON CASTERS

			
L/W 43 cm - A/H 62 cm - P/D 56 cm L/W 16"7/8 - A/H 24"3/8 - P/D 22"1/8	L/W 43 cm - A/H 62 cm - P/D 56 cm L/W 16"7/8 - A/H 24"3/8 - P/D 22"1/8	L/W 43 cm - A/H 62 cm - P/D 56 cm L/W 16"7/8 - A/H 24"3/8 - P/D 22"1/8	L/W 43 cm - A/H 62 cm - P/D 56 cm L/W 16"7/8 - A/H 24"3/8 - P/D 22"1/8
ARES00M1215CC	ARES00M1215CE ARES00M1215CN ARES00M1215CZ	ARES00M1216CC	ARES00M1216CE ARES00M1216CN ARES00M1216CZ

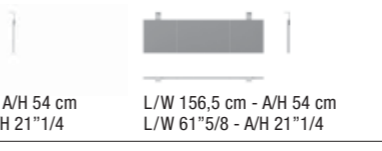
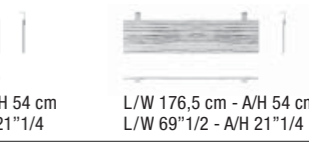
PANNELLI DI CORTESIA / MODESTY PANEL

				
L/W 136,5 cm - A/H 54 cm L/W 53"3/4 - A/H 21"1/4	L/W 136,5 cm - A/H 54 cm L/W 53"3/4 - A/H 21"1/4	L/W 156,5 cm - A/H 54 cm L/W 61"5/8 - A/H 21"1/4	L/W 156,5 cm - A/H 54 cm L/W 61"5/8 - A/H 21"1/4	L/W 176,5 cm - A/H 54 cm L/W 69"1/2 - A/H 21"1/4
ARES00M1207CC	ARES00M1207EE ARES00M1207NN ARES00M1207ZZ	ARES00M1208CC	ARES00M1208EE ARES00M1208NN ARES00M1208ZZ	ARES00M1209CC ARES00M1209EE ARES00M1209NN ARES00M1209ZZ

ALLUNGO / SIDEBBOARD



L/W 118 cm - A/H 5 cm - P/D 60 cm
L/W 46"1/2 - A/H 2" - P/D 23"5/8

L/W 118 cm - A/H 5 cm - P/D 60 cm
L/W 46"1/2 - A/H 2" - P/D 23"5/8

ARES00M1217CE
ARES00M1217CN
ARES00M1217CZ

ARES00M1217EE
ARES00M1217NN
ARES00M1217ZZ

MOBILI ALLUNGO / SIDEBBOARD CABINETS

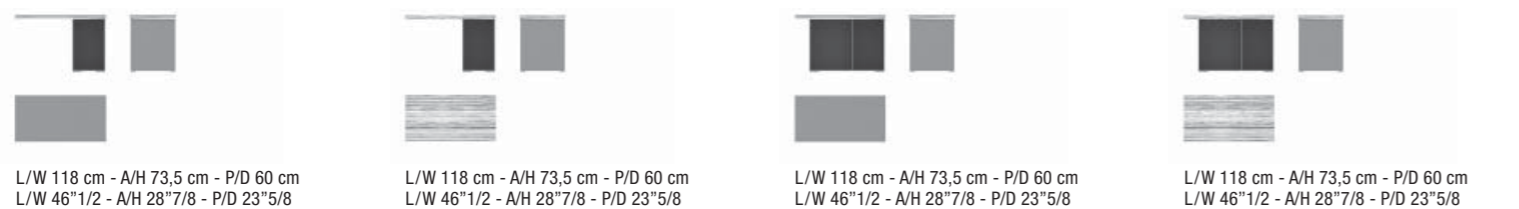

L/W 118 cm - A/H 73,5 cm - P/D 60 cm
L/W 46"1/2 - A/H 28"7/8 - P/D 23"5/8

L/W 118 cm - A/H 73,5 cm - P/D 60 cm
L/W 46"1/2 - A/H 28"7/8 - P/D 23"5/8

L/W 118 cm - A/H 73,5 cm - P/D 60 cm
L/W 46"1/2 - A/H 28"7/8 - P/D 23"5/8

L/W 118 cm - A/H 73,5 cm - P/D 60 cm
L/W 46"1/2 - A/H 28"7/8 - P/D 23"5/8

ARES00M1218CE
ARES00M1218CN
ARES00M1218CZ

ARES00M1218EE
ARES00M1218NN
ARES00M1218ZZ

ARES00M1224CE
ARES00M1224CN
ARES00M1224CZ

ARES00M1224EE
ARES00M1224NN
ARES00M1224ZZ

CASSETTI PER MOBILI ALLUNGO / DRAWERS FOR SIDEBBOARD



L/W 40,5 cm - A/H 66 cm
L/W 16" - A/H 26"

L/W 40,5 cm - A/H 66 cm
L/W 16" - A/H 26"

L/W 40,5 cm - A/H 66 cm
L/W 16" - A/H 26"

L/W 40,5 cm - A/H 66 cm
L/W 16" - A/H 26"

L/W 40,5 cm - A/H 66 cm
L/W 16" - A/H 26"

L/W 40,5 cm - A/H 66 cm
L/W 16" - A/H 26"

ARES00M1219CC
ARES00M1219CN
ARES00M1219CZ

ARES00M1219EE
ARES00M1219NN
ARES00M1219ZZ

ARES00M1220CC
ARES00M1220CN
ARES00M1220CZ

ARES00M1220EE
ARES00M1220NN
ARES00M1220ZZ

ARES00M1221CC
ARES00M1221CN
ARES00M1221CZ

ARES00M1221EE
ARES00M1221NN
ARES00M1221ZZ

L/W 54 cm - A/H 66 cm
L/W 21"1/4 - A/H 26"

L/W 54 cm - A/H 66 cm
L/W 21"1/4 - A/H 26"

L/W 54 cm - A/H 66 cm
L/W 21"1/4 - A/H 26"

L/W 54 cm - A/H 66 cm
L/W 21"1/4 - A/H 26"

L/W 54 cm - A/H 66 cm
L/W 21"1/4 - A/H 26"

L/W 54 cm - A/H 66 cm
L/W 21"1/4 - A/H 26"

ARES00M1225CC
ARES00M1225CN
ARES00M1225CZ

ARES00M1225EE
ARES00M1225NN
ARES00M1225ZZ

ARES00M1226CC
ARES00M1226CN
ARES00M1226CZ

ARES00M1226EE
ARES00M1226NN
ARES00M1226ZZ

ARES00M1227CC
ARES00M1227CN
ARES00M1227CZ

ARES00M1227EE
ARES00M1227NN
ARES00M1227ZZ

ANTE PER MOBILI ALLUNGO / DOORS FOR SIDEBBOARD

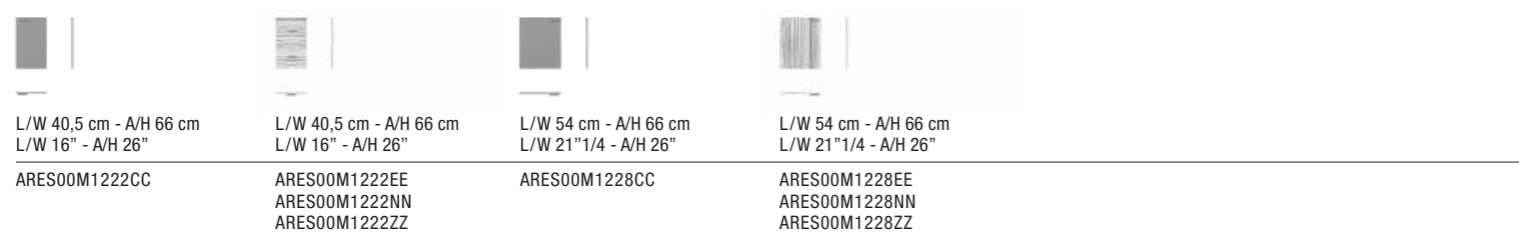

L/W 40,5 cm - A/H 66 cm
L/W 16" - A/H 26"

L/W 40,5 cm - A/H 66 cm
L/W 16" - A/H 26"

L/W 54 cm - A/H 66 cm
L/W 21"1/4 - A/H 26"

L/W 54 cm - A/H 66 cm
L/W 21"1/4 - A/H 26"

ARES00M1222CC
ARES00M1222CN
ARES00M1222CZ

ARES00M1222EE
ARES00M1222NN
ARES00M1222ZZ

ARES00M1228CC
ARES00M1228CN
ARES00M1228CZ

ARES00M1228EE
ARES00M1228NN
ARES00M1228ZZ

MOBILI BASSI / LOW CABINETS



L/W 112 cm - A/H 81,5 cm - P/D 51 cm
L/W 44"1/8 - A/H 32"1/8 - P/D 20"1/8

L/W 167,5 cm - A/H 81,5 cm - P/D 51 cm
L/W 66" - A/H 32"1/8 - P/D 20"1/8

L/W 223 cm - A/H 81,5 cm - P/D 51 cm
L/W 87"3/4 - A/H 32"1/8 - P/D 20"1/8

ARES00M1230CE
ARES00M1230CN
ARES00M1230CZ

ARES00M1231CE
ARES00M1231CN
ARES00M1231CZ

ARES00M1232CE
ARES00M1232CN
ARES00M1232CZ

MOBILI ALTI / HIGH CABINETS

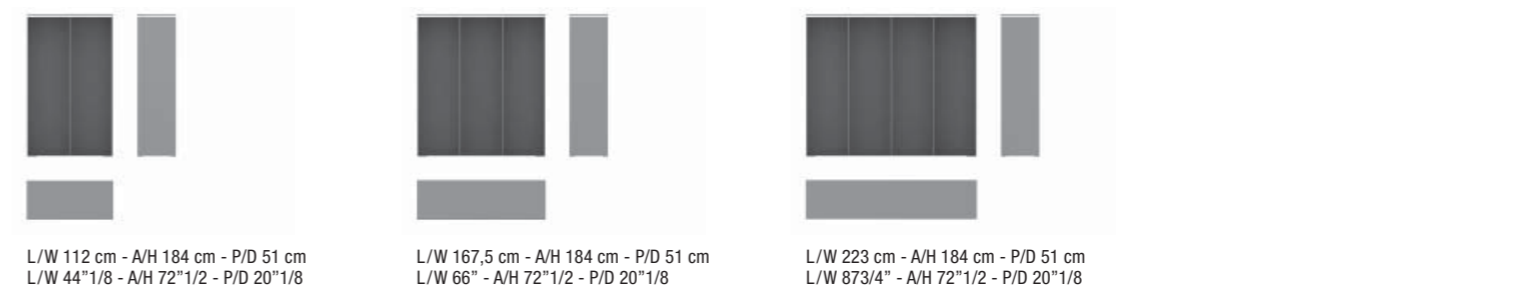

L/W 112 cm - A/H 184 cm - P/D 51 cm
L/W 44"1/8 - A/H 72"1/2 - P/D 20"1/8

L/W 167,5 cm - A/H 184 cm - P/D 51 cm
L/W 66" - A/H 72"1/2 - P/D 20"1/8

L/W 223 cm - A/H 184 cm - P/D 51 cm
L/W 87"3/4 - A/H 72"1/2 - P/D 20"1/8

ARES00M1233CE
ARES00M1233CN
ARES00M1233CZ

ARES00M1241CE
ARES00M1241CN
ARES00M1241CZ

ARES00M1242CE
ARES00M1242CN
ARES00M1242CZ

CASSETTI PER MOBILI / DRAWERS FOR CABINETS

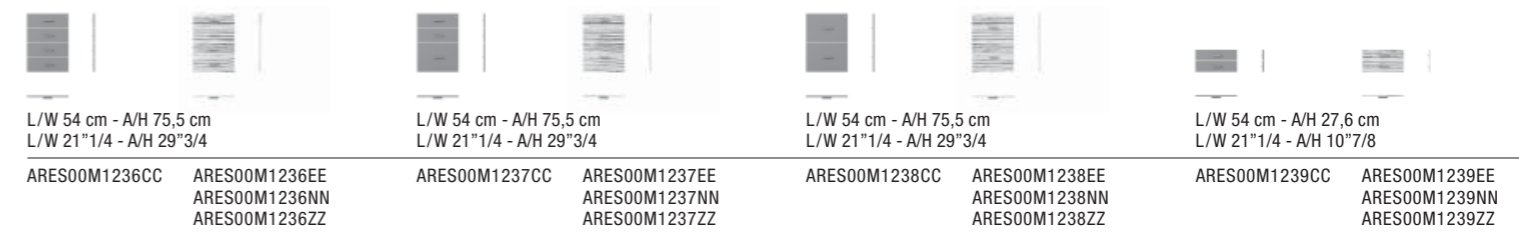

L/W 54 cm - A/H 75,5 cm
L/W 21"1/4 - A/H 29"3/4

L/W 54 cm - A/H 75,5 cm
L/W 21"1/4 - A/H 29"3/4

L/W 54 cm - A/H 75,5 cm
L/W 21"1/4 - A/H 29"3/4

L/W 54 cm - A/H 27,6 cm
L/W 21"1/4 - A/H 10"7/8

ARES00M1236CC
ARES00M1236CN
ARES00M1236CZ

ARES00M1236EE
ARES00M1236NN
ARES00M1236ZZ

ARES00M1237CC
ARES00M1237CN
ARES00M1237CZ

ARES00M1237EE
ARES00M1237NN
ARES00M1237ZZ

ARES00M1238CC
ARES00M1238CN
ARES00M1238CZ

ARES00M1238EE
ARES00M1238NN
ARES00M1238ZZ

ARES00M1239CC
ARES00M1239CN
ARES00M1239CZ

ARES00M1239EE
ARES00M1239NN
ARES00M1239ZZ

ANTE PER MOBILI / DOORS FOR CABINETS

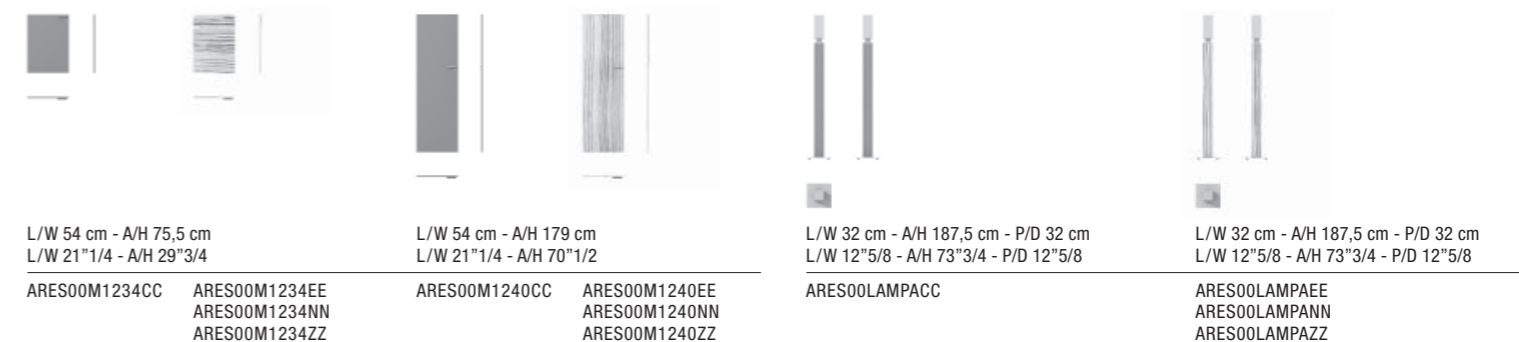

L/W 54 cm - A/H 75,5 cm
L/W 21"1/4 - A/H 29"3/4

L/W 54 cm - A/H 179 cm
L/W 21"1/4 - A/H 70"1/2

L/W 32 cm - A/H 187,5 cm - P/D 32 cm
L/W 12"5/8 - A/H 73"3/4 - P/D 12"5/8

L/W 32 cm - A/H 187,5 cm - P/D 32 cm
L/W 12"5/8 - A/H 73"3/4 - P/D 12"5/8

ARES00M1234CC
ARES00M1234CN
ARES00M1234CZ

ARES00M1234EE
ARES00M1234NN
ARES00M1234ZZ

ARES00M1240CC
ARES00M1240CN
ARES00M1240CZ

ARES00M1240EE
ARES00M1240NN
ARES00M1240ZZ

ARES00LAMPACC
ARES00LAMPACN
ARES00LAMPACZ

ARES00LAMPAAE
ARES00LAMPANN
ARES00LAMPAAZ

ARES00LAMPAAE
ARES00LAMPANN
ARES00LAMPAAZ

TAVOLINI / SMALL TABLES

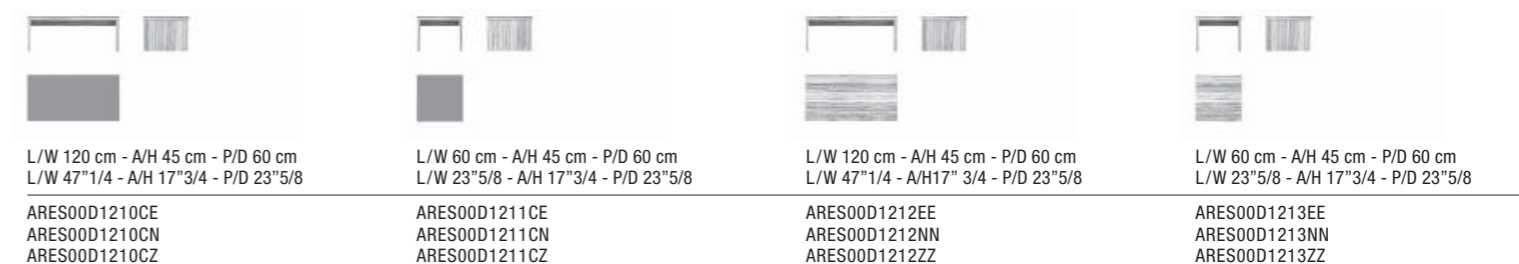

L/W 120 cm - A/H 45 cm - P/D 60 cm
L/W 47"1/4 - A/H 17"3/4 - P/D 23"5/8

L/W 60 cm - A/H 45 cm - P/D 60 cm
L/W 23"5/8 - A/H 17"3/4 - P/D 23"5/8

L/W 120 cm - A/H 45 cm - P/D 60 cm
L/W 47"1/4 - A/H 17"3/4 - P/D 23"5/8

L/W 60 cm - A/H 45 cm - P/D 60 cm
L/W 23"5/8 - A/H 17"3/4 - P/D 23"5/8

ARES00D1210CE
ARES00D1210CN
ARES00D1210CZ

ARES00D1211CE
ARES00D1211CN
ARES00D1211CZ

ARES00D1212EE
ARES00D1212NN
ARES00D1212ZZ

ARES00D1213EE
ARES00D1213NN
ARES00D1213ZZ

ARES00D1212EE
ARES00D1212NN
ARES00D1212ZZ

ARES00D1213EE
ARES00D1213NN
ARES00D1213ZZ

ARES00D1213EE
ARES00D1213NN
ARES00D1213ZZ

POLTRONE / ARMCHAIRS

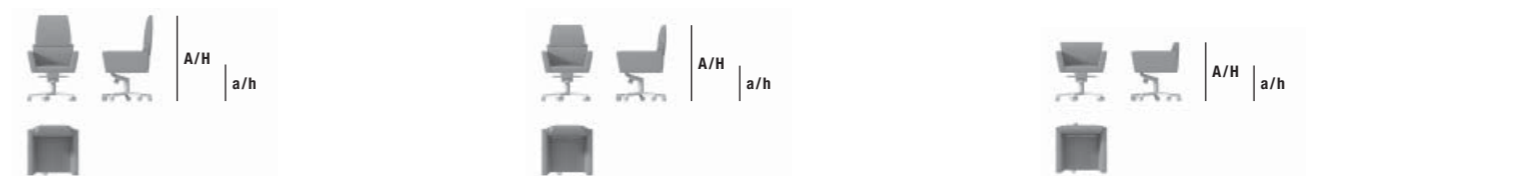

L/W 69 cm - A/H 111-119 cm - a/h 48-54 cm - P/D 66,5 cm
L/W 27"1/8 - A/H 43"3/4-46"7/8 cm - a/h 18"7/8-21"1/4 - P/D 26"1/4

L/W 69 cm - A/H 97-105 cm - a/h 48-54 cm - P/D 66,5 cm
L/W 27"1/8 - A/H 38"1/4-41"3/8 cm - a/h 18"7/8-21"1/4 - P/D 26"1/4

L/W 64 cm - A/H 79-87 cm - a/h 48-54 cm - P/D 66,5 cm
L/W 25"1/4 - A/H 31"1/8-34"1/4 cm - a/h 18"7/8-21"1/4 - P/D 26"1/4

ARES00POL1250

ARES00POL1251

ARES00POL1252



▶ DOLMEN
DESIGN: GUIDO FALESCHINI





Finiture: cristallo e cuoio CF 01. Poltrone in pelle PF 4105.
Finishing: glass and saddle leather CF 01. Armchairs in leather PF 4105.





DOLMEN

DESIGN: GUIDO FALESCHINI

Il piano delle scrivanie e dei tavoli riunione è costituito da un pannello nobilitato nero con uno spessore di 36 mm rivestito completamente in cuoio oppure da un pannello di particelle di legno spessore 36 mm impiallacciato in essenza di zebrano con i bordi rivestiti in cuoio. È disponibile anche un piano in cristallo trasparente e bisellato con spessore 19 mm oppure in cristallo extra-bianco temperato verniciato bianco e bisellato con spessore 12 mm. I sostegni dei piani sono costituiti da una struttura in acciaio verniciata colore grigio antracite con due piedi in acciaio cromati. L'allungo è costituito da un pannello di nobilitato nero rivestito in cuoio ed è fissato da un lato alla struttura della scrivania e dall'altro dispone di una gamba in acciaio verniciato grigio antracite con piede cromato.

La struttura delle cassettiere, dei mobili contenitori e del mobile di servizio è realizzata con pannello nobilitato nero con spessore variabile nei diversi elementi da 18 mm a 30 mm e completamente rivestita in cuoio. Le cassettiere sembrano "sospese" ma sono fissate alla struttura della scrivania tramite degli elementi in acciaio verniciati grigio antracite; i mobili contenitori e di servizio invece hanno due piedini in acciaio verniciato grigio antracite con parte terminale cromata. Le maniglie sono realizzate in acciaio rivestite in cuoio. I frontali dei cassetti e dei classificatori e le ante sono in pannello di particelle di legno impiallacciato con essenza di zebrano oppure in pannello nobilitato nero ricoperto in cuoio.

The desk and conference table top is made of black melamine coated panel thickness mm 36 completely covered by saddle leather or made of particleboard panel thickness mm 36 zebrano-wood veneered with outer edges covered by saddle leather. It is available also with clear chamfered glass top thickness 19 mm or with extra-white chamfered tempered glass white varnished on the underside thickness mm 12. The supports of the tops have a steel frame grey anthracite varnished with two chromed steel feet.

The return is made of a black melamine coated panel covered by saddle leather; he has a grey anthracite varnished leg with chromed foot on one side, while on the other is fixed to the desk. The pedestals, the filing cabinets and the sideboard cabinet have a black melamine coated panel frame with thickness variable for the different elements from 18 mm to 30 mm and completely covered by saddle leather.

The pedestals look like "suspended" but they are fixed to the desk frame through a grey anthracite varnished steel element, whereas the filing and sideboard cabinets have two feet in grey anthracite varnished steel with chromed end side. The steel handles are covered by saddle leather. The drawers, files and doors fronts are made in particleboard panel zebrano-wood veneered or in black melamine coated panel covered by saddle leather.



Finiture: zebrano e cuoio CF 02.
Finishing: zebra-wood and saddle leather CF 02.

SCRIVANIE / DESKS

L/W 200 cm - A/H 74 cm - P/D 100 cm L/W 78"3/4 - A/H 29"1/8 - P/D 39"3/8	L/W 200 cm - A/H 74 cm - P/D 100 cm L/W 78"3/4 - A/H 29"1/8 - P/D 39"3/8	L/W 200 cm - A/H 74 cm - P/D 100 cm L/W 78"3/4 - A/H 29"1/8 - P/D 39"3/8	L/W 200 cm - A/H 74 cm - P/D 100 cm L/W 78"3/4 - A/H 29"1/8 - P/D 39"3/8
DOLMEN000670A	DOLMEN000670A	DOLMEN000670B	DOLMEN000670Z
L/W 220 cm - A/H 74 cm - P/D 115 cm L/W 86"5/8 - A/H 29"1/8 - P/D 45"1/4	L/W 220 cm - A/H 74 cm - P/D 115 cm L/W 86"5/8 - A/H 29"1/8 - P/D 45"1/4	L/W 220 cm - A/H 74 cm - P/D 115 cm L/W 86"5/8 - A/H 29"1/8 - P/D 45"1/4	L/W 220 cm - A/H 74 cm - P/D 115 cm L/W 86"5/8 - A/H 29"1/8 - P/D 45"1/4
DOLMEN000671A	DOLMEN000671A	DOLMEN000671B	DOLMEN000671Z

MOBILI ALLUNGO / RETURN CABINETS

L/W 185 cm - A/H 65 cm - P/D 80 cm L/W 72"7/8 - A/H 25"5/8 - P/D 31"1/2	L/W 185 cm - A/H 65 cm - P/D 80 cm L/W 72"7/8 - A/H 25"5/8 - P/D 31"1/2
DOLMEN000674	DOLMEN000675

CASSETTIERE PER SCRIVANIE / PEDESTAL FOR DESKS

L/W 43 cm - A/H 25,5 cm - P/D 85,5 cm L/W 16"7/8 - A/H 10" - P/D 33"5/8	L/W 43 cm - A/H 25,5 cm - P/D 85,5 cm L/W 16"7/8 - A/H 10" - P/D 33"5/8	L/W 43 cm - A/H 34,5 cm - P/D 85,5 cm L/W 16"7/8 - A/H 13"1/2 - P/D 33"5/8	L/W 43 cm - A/H 34,5 cm - P/D 85,5 cm L/W 16"7/8 - A/H 13"1/2 - P/D 33"5/8	L/W 43 cm - A/H 34,5 cm - P/D 85,5 cm L/W 16"7/8 - A/H 13"1/2 - P/D 33"5/8	L/W 43 cm - A/H 34,5 cm - P/D 85,5 cm L/W 16"7/8 - A/H 13"1/2 - P/D 33"5/8
DOLMEN000672	DOLMEN000672Z	DOLMEN000689	DOLMEN000689Z	DOLMEN000690	DOLMEN000690Z
L/W 43 cm - A/H 25,5 cm - P/D 75,5 cm L/W 16"7/8 - A/H 10" - P/D 29"3/4	L/W 43 cm - A/H 25,5 cm - P/D 75,5 cm L/W 16"7/8 - A/H 10" - P/D 29"3/4	L/W 43 cm - A/H 34,5 cm - P/D 75,5 cm L/W 16"7/8 - A/H 13"1/2 - P/D 29"3/4	L/W 43 cm - A/H 34,5 cm - P/D 75,5 cm L/W 16"7/8 - A/H 13"1/2 - P/D 29"3/4	L/W 43 cm - A/H 34,5 cm - P/D 75,5 cm L/W 16"7/8 - A/H 13"1/2 - P/D 29"3/4	L/W 43 cm - A/H 34,5 cm - P/D 75,5 cm L/W 16"7/8 - A/H 13"1/2 - P/D 29"3/4
DOLMEN000673	DOLMEN000673Z	DOLMEN000691	DOLMEN000691Z	DOLMEN000692	DOLMEN000692Z

TAVOLI CONFERENZA / CONFERENCE TABLES

L/W 220 cm - A/H 74 cm - P/D 115 cm L/W 86"5/8 - A/H 29"1/8 - P/D 45"1/4	L/W 220 cm - A/H 74 cm - P/D 115 cm L/W 86"5/8 - A/H 29"1/8 - P/D 45"1/4	L/W 220 cm - A/H 74 cm - P/D 115 cm L/W 86"5/8 - A/H 29"1/8 - P/D 45"1/4	L/W 220 cm - A/H 74 cm - P/D 115 cm L/W 86"5/8 - A/H 29"1/8 - P/D 45"1/4
DOLMEN000676	DOLMEN000676A	DOLMEN000676B	DOLMEN000676Z

L/W 280 cm - A/H 74 cm - P/D 120 cm L/W 110"1/4 - A/H 29"1/8 - P/D 47"1/4	L/W 280 cm - A/H 74 cm - P/D 120 cm L/W 110"1/4 - A/H 29"1/8 - P/D 47"1/4	L/W 280 cm - A/H 74 cm - P/D 120 cm L/W 110"1/4 - A/H 29"1/8 - P/D 47"1/4	L/W 280 cm - A/H 74 cm - P/D 120 cm L/W 110"1/4 - A/H 29"1/8 - P/D 47"1/4
DOLMEN000677	DOLMEN000677A	DOLMEN000677B	DOLMEN000677Z

L/W 130 cm - A/H 74 cm - P/D 130 cm L/W 51"1/4 - A/H 29"1/8 - P/D 51"1/4	L/W 130 cm - A/H 74 cm - P/D 130 cm L/W 51"1/4 - A/H 29"1/8 - P/D 51"1/4	L/W 130 cm - A/H 74 cm - P/D 130 cm L/W 51"1/4 - A/H 29"1/8 - P/D 51"1/4	L/W 130 cm - A/H 74 cm - P/D 130 cm L/W 51"1/4 - A/H 29"1/8 - P/D 51"1/4
DOLMEN000693	DOLMEN000693A	DOLMEN000693B	DOLMEN000693Z

MOBILI BASSI / LOW CABINETS

L/W 100,5 cm - A/H 71 cm - P/D 42,5 cm L/W 39"1/2 - A/H 28" - P/D 16"3/4	L/W 100,5 cm - A/H 71 cm - P/D 42,5 cm L/W 39"1/2 - A/H 28" - P/D 16"3/4	L/W 100,5 cm - A/H 71 cm - P/D 42,5 cm L/W 39"1/2 - A/H 28" - P/D 16"3/4	L/W 100,5 cm - A/H 71 cm - P/D 42,5 cm L/W 39"1/2 - A/H 28" - P/D 16"3/4
DOLMEN000678	DOLMEN000678Z	DOLMEN000679	DOLMEN000679Z

MOBILI BASSI / LOW CABINETS

L/W 100,5 cm - A/H 71 cm - P/D 42,5 cm L/W 39"1/2 - A/H 28" - P/D 16"3/4	L/W 100,5 cm - A/H 71 cm - P/D 42,5 cm L/W 39"1/2 - A/H 28" - P/D 16"3/4	L/W 100,5 cm - A/H 71 cm - P/D 42,5 cm L/W 39"1/2 - A/H 28" - P/D 16"3/4	L/W 100,5 cm - A/H 71 cm - P/D 42,5 cm L/W 39"1/2 - A/H 28" - P/D 16"3/4
DOLMEN000688	DOLMEN000688Z	DOLMEN000687	DOLMEN000687Z

STRUTTURA PER MOBILI BASSI / FRAME FOR LOW CABINETS

L/W 167,5 cm - A/H 89 cm - P/D 42,5 cm L/W 66" - A/H 35" - P/D 16"3/4	L/W 223 cm - A/H 89 cm - P/D 42,5 cm L/W 87"3/4 - A/H 35" - P/D 16"3/4
DOLMEN000680	DOLMEN000681

ANTE PER MOBILI / DOORS

L/W 52,5 cm - A/H 70 cm L/W 20"5/8 - A/H 27"1/2	L/W 52,5 cm - A/H 70 cm L/W 20"5/8 - A/H 27"1/2
DOLMEN000682	DOLMEN000682Z

CASSETTI PER MOBILI / DRAWERS

L/W 52,5 cm - A/H 70 cm L/W 20"5/8 - A/H 27"1/2	L/W 52,5 cm - A/H 70 cm L/W 20"5/8 - A/H 27"1/2	L/W 52,5 cm - A/H 70 cm L/W 20"5/8 - A/H 27"1/2	L/W 52,5 cm - A/H 70 cm L/W 20"5/8 - A/H 27"1/2	L/W 52,5 cm - A/H 70 cm L/W 20"5/8 - A/H 27"1/2	L/W 52,5 cm - A/H 70 cm L/W 20"5/8 - A/H 27"1/2
DOLMEN000684	DOLMEN000684Z	DOLMEN000685	DOLMEN000685Z	DOLMEN000686	DOLMEN000686Z

TAVOLINI / SMALL TABLES

L/W 60 cm - A/H 45 cm - P/D 60 cm L/W 23"5/8 - A/H 17"3/4 - P/D 23"5/8	L/W 60 cm - A/H 45 cm - P/D 60 cm L/W 23"5/8 - A/H 17"3/4 - P/D 23"5/8	L/W 120 cm - A/H 45 cm - P/D 60 cm L/W 47"1/4 - A/H 17"3/4 - P/D 23"5/8	L/W 120 cm - A/H 45 cm - P/D 60 cm L/W 47"1/4 - A/H 17"3/4 - P/D 23"5/8
DOLMEN000694A	DOLMEN000694Z	DOLMEN000695A	DOLMEN000695Z



► METEORA
DESIGN: GUIDO FALESCHINI





Finiture: ebano macassar con finitura lucida 100 gloss e cuoio CF 27. Poltrone in cuoio CF 27 e pelle PF 4134.
Finishings: macassar ebony wood with hi-gloss finishing with 100 gloss and saddle leather CF 27. Armchairs in saddle leather CF 27 and leather PF 4134.









Finiture: cuoio CF 22 e laminato nero. Poltrone in cuoio CF 22 e pelle PF 4129.
Finishings: saddle leather CF 22 and black laminate. Armchairs in saddle leather CF 22 and leather PF 4129.

La collezione per ufficio METEORA, disegnata dall'Architetto Guido Faleschini secondo un progetto che risale ai primi anni '80, si ripresenta oggi in una nuova veste più attuale ed arricchita di nuovi preziosi materiali.

Oltre al cuoio dei rivestimenti ed al laminato nero è stata introdotta una nuova e prestigiosa essenza tipo ebano volta ad impreziosire la serie di mobili, scrivanie e tavoli conferenze rendendoli perfetti per ambienti direzionali.

Il design moderno dei diversi elementi caratterizzato dalle grandi dimensioni, dalla ricchezza dei materiali e dei particolari è più che mai attuale e dal gusto contemporaneo.

Il piano delle scrivanie e dei tavoli riunione è costituito da un pannello nobilitato nero con uno spessore di 40 mm completamente rivestito in cuoio che viene poi fissato a delle fasce laterali che costituiscono i veri e propri sostegni della scrivania; questi pannelli sono costituiti da una cornice esterna in legno massello di pioppo con taglio a 45 gradi, completamente rivestita in cuoio, alla quale è fissato un pannello centrale di nobilitato nero o impiallacciato in ebano.

Le cassettiere e l'allungo hanno una struttura in pannello nobilitato nero con top rivestito in cuoio; le ante ed i cassetti sono in pannello nobilitato nero rivestiti in cuoio.

La struttura dei mobili contenitori è realizzata con pannello nobilitato nero con spessore variabile nei diversi elementi da 8 mm a 30 mm.; il top completamente rivestito in cuoio è disponibile per i mobili h. 98 cm mentre è assente per quelli h. 205 cm. In entrambe le altezze il mobile ha una fascia di chiusura laterale; questo è costituito da una cornice esterna in legno massello di pioppo con taglio a 45 gradi, completamente rivestita in cuoio, alla quale è fissato un pannello di nobilitato nero o impiallacciato in ebano.

Le ante ed i cassetti sono realizzati in pannello truciolare nobilitato nero completamente rivestiti in cuoio. Le maniglie sono in PVC nero.

The METEORA office collection, designed by the Architect Guido Faleschini according to a project going back to the beginning of 80's, comes up again in a new dress more current and enriched of new precious materials.

Further to the saddle leather upholstery and to the black laminate it has been introduced a new and prestigious essence ebony type, to enhance the series of desks, cabinets and conference tables bringing them perfect for directional environments.

The modern design of the different elements characterized by the big dimensions, by the richness of the materials and of the details is more than ever current and of contemporary taste.

The desks and the conference tables top are made in black melamine coated panel thickness 40 mm completely covered by saddle leather and are fixed to the lateral sides which are the real supports of the desk; these side panels are made by a solid poplar wood frame with a shape cut at 45 degrees, completely covered by saddle leather, and with a central black melamine coated panel or veneered in ebony wood.

The pedestal and the extension have a frame in black melamine coated panel with the top covered by saddle leather; the doors and the drawers are in black melamine coated panel covered by saddle leather.

The frame of the cabinet is made by a black melamine coated panel (with a variable thickness from 8 mm to 30 mm for the different elements); the top, completely covered by saddle leather, is available only for the 98 cm high cabinet and not for the 205 cm high cabinet. Both the 98 cm and 205 cm high cabinets have a side ending panel; this is made by solid poplar wood frame with a shape cut at 45 degrees, completely covered by saddle leather with a central black melamine coated panel or veneered in ebony wood.

The doors and the drawers are made by a black melamine coated panel completely covered by a saddle leather. The handles are in black PVC.

SCRIVANIE / DESKS



L/W 240 cm - A/H 74 cm - P/D 240
L/W 94"1/2 - A/H 29"1/8 - P/D 94"1/2

METEOR0000100

L/W 240 cm - A/H 74 cm - P/D 240
L/W 94"1/2 - A/H 29"1/8 - P/D 94"1/2

METEOR000100E

L/W 240 cm - A/H 74 cm - P/D 240
L/W 94"1/2 - A/H 29"1/8 - P/D 94"1/2

METEOR00100EE

MOBILE LATERALE / SIDEBBOARD



L/W 120 cm - A/H 74 cm - P/D 49
L/W 47"1/4 - A/H 29"1/8 - P/D 19"1/4

METEOR0000101

SCRIVANIE / DESKS

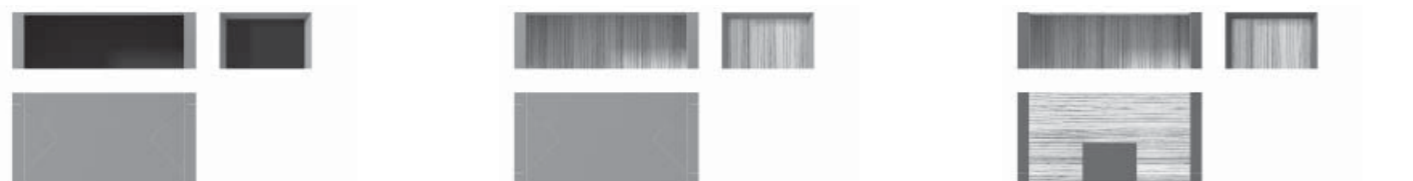

L/W 240 cm - A/H 74 cm - P/D 120
L/W 94"1/2 - A/H 29"1/8 - P/D 47"1/4

METEOR0000102

L/W 240 cm - A/H 74 cm - P/D 120
L/W 94"1/2 - A/H 29"1/8 - P/D 47"1/4

METEOR000102E

L/W 240 cm - A/H 74 cm - P/D 120
L/W 94"1/2 - A/H 29"1/8 - P/D 47"1/4

METEOR00102EE

MOBILE LATERALE / SIDEBBOARD

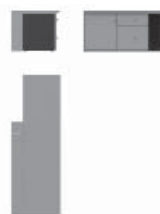

L/W 181 cm - A/H 53 cm - P/D 64
L/W 71"1/4 - A/H 20"7/8 - P/D 25"1/4

METEOR0000103

SCRIVANIE / DESKS



L/W 210 cm - A/H 74 cm - P/D 210
L/W 82"5/8 - A/H 29"1/8 - P/D 82"5/8

METEOR0000104

L/W 210 cm - A/H 74 cm - P/D 210
L/W 82"5/8 - A/H 29"1/8 - P/D 82"5/8

METEOR000104E

L/W 210 cm - A/H 74 cm - P/D 210
L/W 82"5/8 - A/H 29"1/8 - P/D 82"5/8

METEOR00104EE

MOBILE LATERALE / SIDEBBOARD

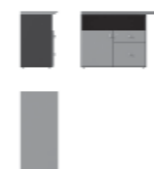

L/W 105 cm - A/H 74 cm - P/D 49
L/W 41"3/8 - A/H 29"1/8 - P/D 19"1/4

METEOR0000105

SCRIVANIE / DESKS

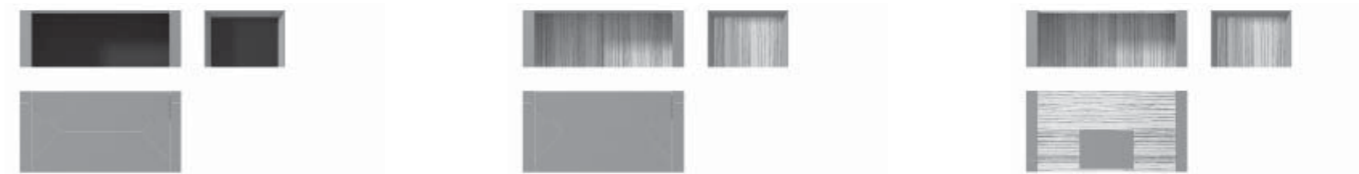

L/W 210 cm - A/H 74 cm - P/D 105
L/W 82"5/8 - A/H 29"1/8 - P/D 41"3/8

METEOR0000106

L/W 210 cm - A/H 74 cm - P/D 105
L/W 82"5/8 - A/H 29"1/8 - P/D 41"3/8

METEOR000106E

L/W 210 cm - A/H 74 cm - P/D 105
L/W 82"5/8 - A/H 29"1/8 - P/D 41"3/8

METEOR00106EE

MOBILE LATERALE / SIDEBBOARD



L/W 166 cm - A/H 53 cm - P/D 64
L/W 65"3/8 - A/H 20"7/8 - P/D 25"1/4

METEOR0000107

SCRIVANIE / DESKS

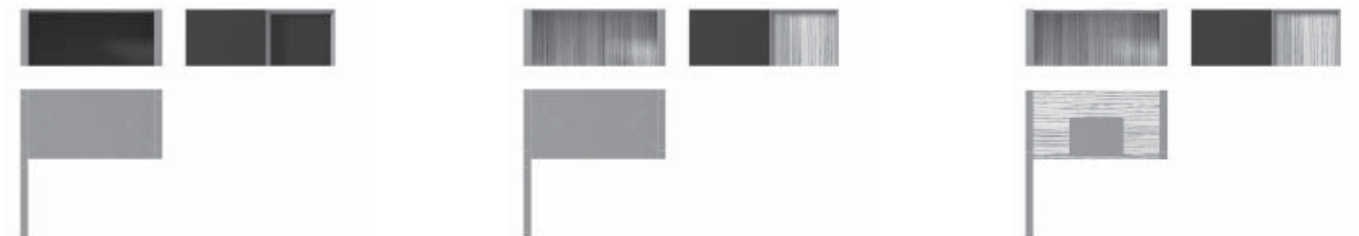

L/W 185 cm - A/H 74 cm - P/D 195
L/W 72"7/8 - A/H 29"1/8 - P/D 76"3/4

METEOR0000128

L/W 185 cm - A/H 74 cm - P/D 195
L/W 72"7/8 - A/H 29"1/8 - P/D 76"3/4

METEOR000128E

L/W 185 cm - A/H 74 cm - P/D 195
L/W 72"7/8 - A/H 29"1/8 - P/D 76"3/4

METEOR00128EE

MOBILE LATERALE / SIDEBOARD



L/W 105 cm - A/H 74 cm - P/D 49
L/W 41³/₈ - A/H 29¹/₈ - P/D 19¹/₄

METEOR0000129

SCRIVANIE / DESKS

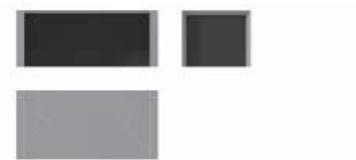

L/W 185 cm - A/H 74 cm - P/D 90
L/W 72⁷/₈ - A/H 29¹/₈ - P/D 35¹/₂

METEOR0000130

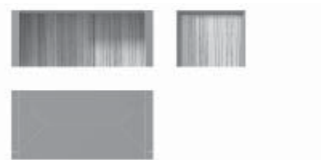

L/W 185 cm - A/H 74 cm - P/D 90
L/W 72⁷/₈ - A/H 29¹/₈ - P/D 35¹/₂

METEOR000130E

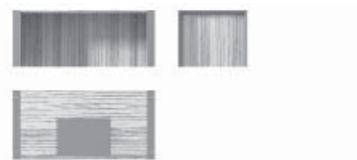

L/W 185 cm - A/H 74 cm - P/D 90
L/W 72⁷/₈ - A/H 29¹/₈ - P/D 35¹/₂

METEOR00130EE

MOBILE LATERALE / SIDEBOARD



L/W 164 cm - A/H 53 cm - P/D 59
L/W 64¹/₂ - A/H 20⁷/₈ - P/D 23¹/₄

METEOR0000131

CASSETTIERA / PEDESTAL



L/W 42,5 cm - A/H 60,5 cm - P/D 61
L/W 16³/₄ - A/H 23³/₄ - P/D 24"

METEOR0000108

MOBILI BASSI / LOW CABINETS



L/W 136 cm - A/H 98 cm - P/D 48 cm
L/W 53¹/₂ - A/H 38¹/₂ - P/D 18⁷/₈

METEOR0000109

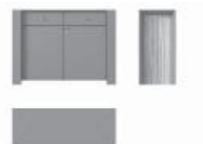

L/W 136 cm - A/H 98 cm - P/D 48 cm
L/W 53¹/₂ - A/H 38¹/₂ - P/D 18⁷/₈

METEOR000109E



L/W 191 cm - A/H 98 cm - P/D 48 cm
L/W 75¹/₄ - A/H 38¹/₂ - P/D 18⁷/₈

METEOR0000110



L/W 191 cm - A/H 98 cm - P/D 48 cm
L/W 75¹/₄ - A/H 38¹/₂ - P/D 18⁷/₈

METEOR000110E



L/W 246 cm - A/H 98 cm - P/D 48 cm
L/W 96⁷/₈ - A/H 38¹/₂ - P/D 18⁷/₈

METEOR0000111



L/W 246 cm - A/H 98 cm - P/D 48 cm
L/W 96⁷/₈ - A/H 38¹/₂ - P/D 18⁷/₈

METEOR000111E



L/W 301 cm - A/H 98 cm - P/D 48 cm
L/W 118¹/₂ - A/H 38¹/₂ - P/D 18⁷/₈

METEOR0000112



L/W 301 cm - A/H 98 cm - P/D 48 cm
L/W 118¹/₂ - A/H 38¹/₂ - P/D 18⁷/₈

METEOR000112E

RIPIANO / SHELF



L/W 52 cm - P/D 36,5 cm
L/W 20¹/₂ - P/D 14³/₈

METEOR0000113

MOBILI ALTI / HIGH CABINETS



L/W 56 cm - A/H 205 cm - P/D 42 cm
L/W 22" - A/H 80³/₄ - P/D 16¹/₂

METEOR0000114

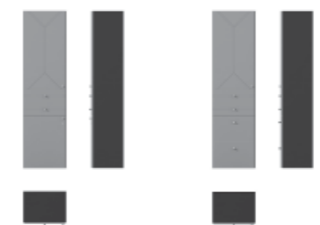

L/W 56 cm - A/H 205 cm - P/D 42 cm
L/W 22" - A/H 80³/₄ - P/D 16¹/₂

METEOR0000115



L/W 56 cm - A/H 205 cm - P/D 42 cm
L/W 22" - A/H 80³/₄ - P/D 16¹/₂

METEOR0000116

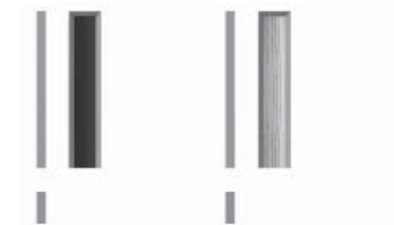

L/W 42 cm - A/H 205 cm - P/D 12 cm
L/W 16¹/₂ - A/H 80³/₄ - P/D 4³/₄

METEOR0000117

METEOR000118E

TAVOLI CONFERENZA / CONFERENCE TABLES

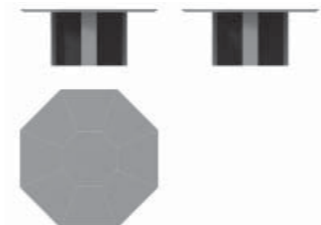

L/W 180 cm - A/H 74 cm - P/D 180 cm
L/W 70⁷/₈ - A/H 29¹/₈ - P/D 70⁷/₈

METEOR0000121



L/W 180 cm - A/H 74 cm - P/D 180 cm
L/W 70⁷/₈ - A/H 29¹/₈ - P/D 70⁷/₈

METEOR000121E

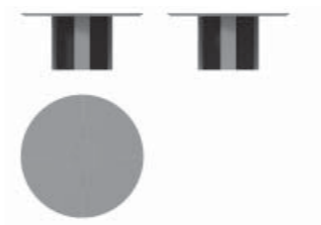

L/W 160 cm - A/H 74 cm - P/D 160 cm
L/W 63" - A/H 29¹/₈ - P/D 63"

METEOR0000125

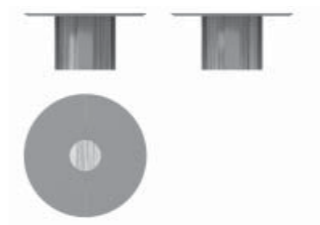

L/W 160 cm - A/H 74 cm - P/D 160 cm
L/W 63" - A/H 29¹/₈ - P/D 63"

METEOR000125E

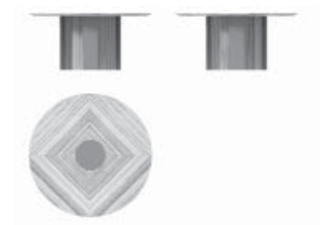

L/W 160 cm - A/H 74 cm - P/D 160 cm
L/W 63" - A/H 29¹/₈ - P/D 63"

METEOR00125EE

TAVOLI CONFERENZA / CONFERENCE TABLES



L/W 225 cm - A/H 74 cm - P/D 120 cm
L/W 88¹/₂ - A/H 29¹/₈ - P/D 47¹/₄

METEOR0000122



L/W 225 cm - A/H 74 cm - P/D 120 cm
L/W 88¹/₂ - A/H 29¹/₈ - P/D 47¹/₄

METEOR000122E



L/W 225 cm - A/H 74 cm - P/D 120 cm
L/W 88¹/₂ - A/H 29¹/₈ - P/D 47¹/₄

METEOR00122EE



L/W 450 cm - A/H 74 cm - P/D 120 cm
L/W 177¹/₈ - A/H 29¹/₈ - P/D 47¹/₄

METEOR0000123



L/W 450 cm - A/H 74 cm - P/D 120 cm
L/W 177¹/₈ - A/H 29¹/₈ - P/D 47¹/₄

METEOR000123E

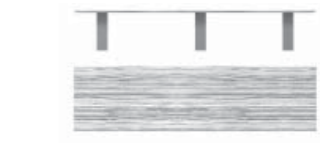

L/W 450 cm - A/H 74 cm - P/D 120 cm
L/W 177¹/₈ - A/H 29¹/₈ - P/D 47¹/₄

METEOR00123EE

TAVOLI CONFERENZA / CONFERENCE TABLES



L/W 217 cm - A/H 74 cm - P/D 80 cm
L/W 85¹/₂" - A/H 29¹/₈" - P/D 31¹/₂"

METEOR0000124



L/W 217 cm - A/H 74 cm - P/D 80 cm
L/W 85¹/₂" - A/H 29¹/₈" - P/D 31¹/₂"

METEOR000124E

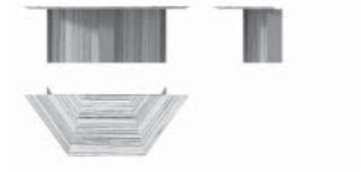

L/W 217 cm - A/H 74 cm - P/D 80 cm
L/W 85¹/₂" - A/H 29¹/₈" - P/D 31¹/₂"

METEOR00124EE



L/W 150 cm - A/H 74 cm - P/D 80 cm
L/W 59" - A/H 29¹/₈" - P/D 31¹/₂"

METEOR0000125



L/W 150 cm - A/H 74 cm - P/D 80 cm
L/W 59" - A/H 29¹/₈" - P/D 31¹/₂"

METEOR000125E



L/W 150 cm - A/H 74 cm - P/D 80 cm
L/W 59" - A/H 29¹/₈" - P/D 31¹/₂"

METEOR00125EE



L/W 150 cm - A/H 74 cm - P/D 80 cm
L/W 59" - A/H 29¹/₈" - P/D 31¹/₂"

METEOR00125EA



L/W 150 cm - A/H 74 cm - P/D 80 cm
L/W 59" - A/H 29¹/₈" - P/D 31¹/₂"

METEOR00126EE

TAVOLINI / SMALL TABLES



L/W 80 cm - A/H 40 cm - P/D 80 cm
L/W 31¹/₂" - A/H 15³/₄" - P/D 31¹/₂"

METEOR0000146



L/W 120 cm - A/H 40 cm - P/D 60 cm
L/W 47¹/₄" - A/H 15³/₄" - P/D 23⁵/₈"

METEOR0000147

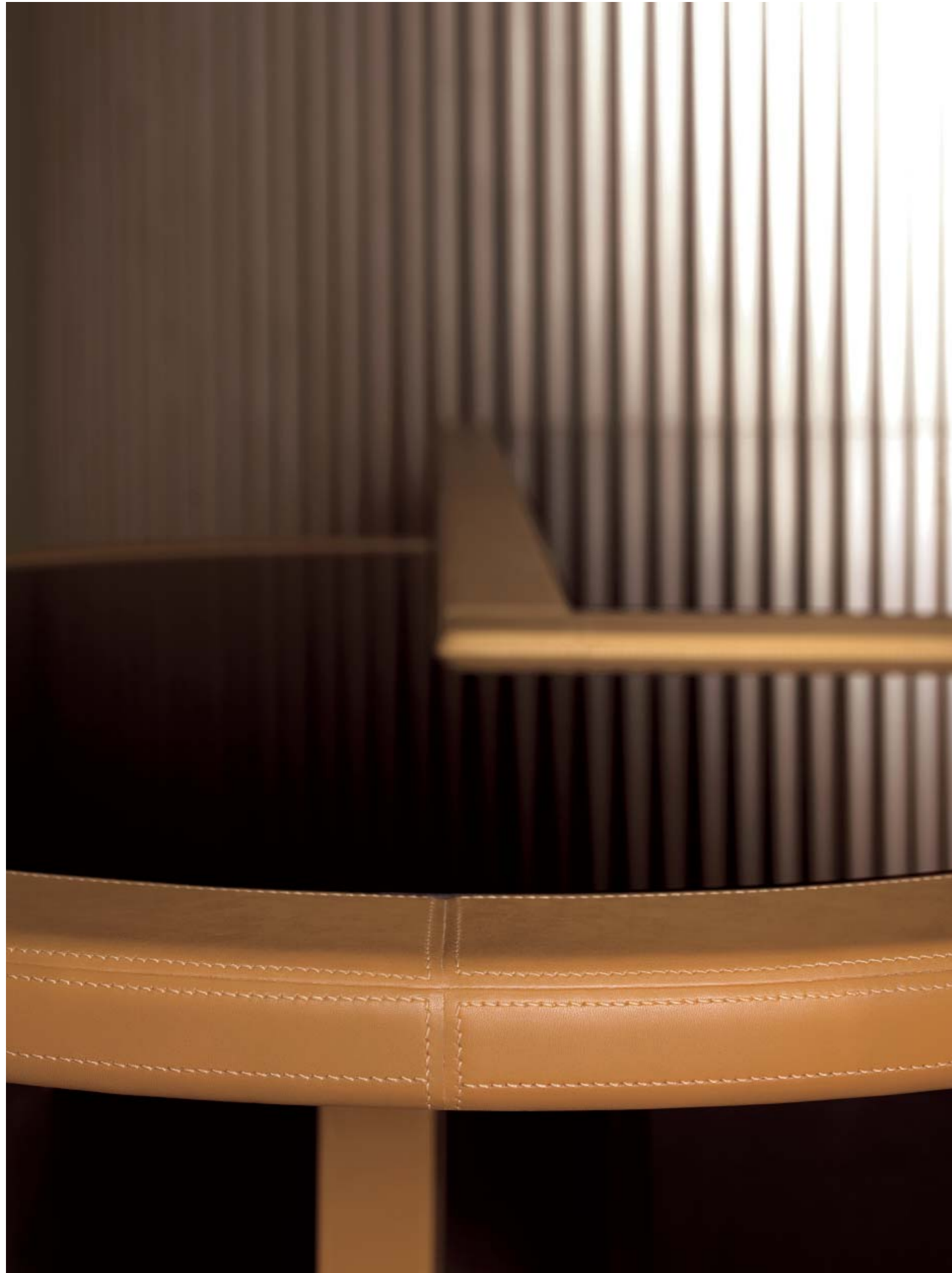

ELITE

DESIGN: GUIDO FALESCHINI





Finiture: cuoio CF 22 e laminato nero. Poltrone in pelle PF 4129.
Finishings: saddle leather CF 22 and black laminate. Armchairs in leather PF 4129.



I piani e le gambe delle scrivanie, delle estensioni circolari e dei tavoli riunione e gli elementi di assemblaggio per i mobili sono realizzati in pannello tamburato 58 mm con bordi e traversi in massello di faggio, cartone a nido d'ape spessore 35 mm e due pannelli di nobilitato nero sulle due facce. Il top può essere completamente rivestito in cuoio, in cristallo verniciato nero con bordi in cuoio oppure in laminato nero con bordi in cuoio.

La struttura delle cassettiere e degli allunghi è in pannello nobilitato nero; il top, lo schienale e i piedini sono sempre rivestiti in cuoio. I frontali dei cassetti e classificatori sono in pannello nobilitato nero rivestiti in cuoio.

I mobili contenitori hanno una struttura in pannello nobilitato nero con spessore variabile nei diversi elementi da 8 mm a 30 mm. Il top è rivestito completamente in cuoio nei mobili con h. 80 cm mentre nei mobili con h. 182 cm è rivestito solo il bordo perimetrale. I frontali delle ante e dei cassetti sono in pannello nobilitato nero e rivestiti in cuoio oppure in cristallo fumè con cornice rivestita in cuoio.

Le maniglie sono in PVC nero con inserto in cuoio.

Le sedie hanno una struttura in tubolare d'acciaio verniciata a polveri epossidiche in colore nero. Lo schienale è in poliuretano integrale nero con inserto in acciaio mentre la seduta è costituita da un pannello di multistrato di faggio rivestito da una lastra di poliuretano espanso con ovatta poliestere e quindi tessuto o pelle.



The tops and the legs of the desks of the round extension, of the conference tables and of the assembly elements for the cabinets are made by honeycomb fiberboard thickness 58 mm that is composed by a solid beechwood frame, honeycomb carton thickness 35 mm and two black melamine coated panels on the two faces (top and bottom). The top can be completely covered by saddle leather either with outer edges covered by saddle leather and an inlay of black varnished glass on the underside or of black laminate.



The pedestals and the extension frame is in black melamine coated panel; the top, the back and the feet are always covered by saddle leather. The drawers and files fronts are in black melamine coated panel covered by saddle leather.

The cabinets frame is in black melamine coated panel (with a variable thickness from 8 mm to 30 mm for the different elements). On the 80 cm high cabinet the top is completely covered by saddle leather while on the 182 cm. high cabinet is covered in saddle leather only on the outer edges. The doors, the drawers and the files fronts are in black melamine coated panel covered by saddle leather or in smoked glass with the outer frame covered by saddle leather. The handles are in black PVC with a saddle leather insert.

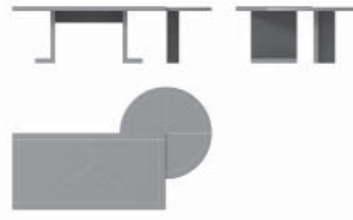
The visitor chair frame is in tubular steel black epoxy powder varnished. The back has a tubular steel frame embedded in black self skinning cold formed polyurethane while the seat is a beechwood multiply panel with a polyurethane foam sheet covered by a polyester wadding and then fabric or leather.

SCRIVANIE / DESKS

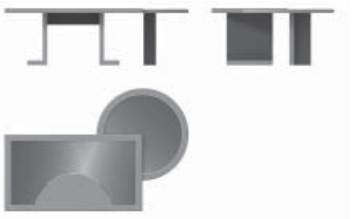
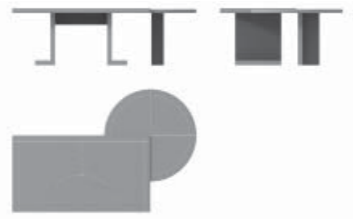

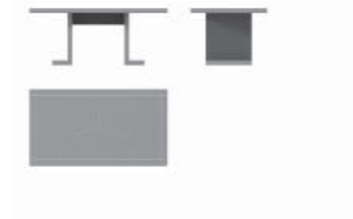
			
L/W 260 cm - A/H 74 cm - P/D 160 cm - Ø 120 cm L/W 102"3/8 - A/H 29"1/8 - P/D 63" - Ø 47"1/4	L/W 260 cm - A/H 74 cm - P/D 160 cm - Ø 120 cm L/W 102"3/8 - A/H 29"1/8 - P/D 63" - Ø 47"1/4	L/W 200 cm - A/H 74 cm - P/D 100 cm L/W 78"3/4 - A/H 29"1/8 - P/D 39"3/8	L/W 200 cm - A/H 74 cm - P/D 100 cm L/W 78"3/4 - A/H 29"1/8 - P/D 39"3/8
ELITE0000300	ELITE0000300A	ELITE0000301	ELITE0000301A

			
L/W 240 cm - A/H 74 cm - P/D 160 cm - Ø 120 cm L/W 94"1/2 - A/H 29"1/8 - P/D 63" - Ø 47"1/4	L/W 240 cm - A/H 74 cm - P/D 160 cm - Ø 120 cm L/W 94"1/2 - A/H 29"1/8 - P/D 63" - Ø 47"1/4	L/W 180 cm - A/H 74 cm - P/D 100 cm L/W 70"7/8 - A/H 29"1/8 - P/D 39"3/8	L/W 180 cm - A/H 74 cm - P/D 100 cm L/W 70"7/8 - A/H 29"1/8 - P/D 39"3/8
ELITE0000302	ELITE0000302A	ELITE0000303	ELITE0000303A

MOBILE ALLUNGO / RETURN CABINET

L/W 168 cm - A/H 55 cm - P/D 46 cm L/W 66"1/8 - A/H 21"5/8 - P/D 18"1/8
ELITE0000306





CASSETTIERE / PEDESTALS

	
L/W 46 cm - A/H 55 cm - P/D 78 cm L/W 18"1/8 - A/H 21"5/8 - P/D 30"3/4	L/W 46 cm - A/H 55 cm - P/D 78 cm L/W 18"1/8 - A/H 21"5/8 - P/D 30"3/4
ELITE0000307	ELITE0000307A





CASSETTINO / PENCIL DRAWER

L/W 42,5 cm - A/H 4,8 cm L/W 16"3/4 - A/H 1"7/8
ELITE0000307B







TAVOLI RIUNIONE / CONFERENCE TABLES

			
L/W 280 cm - A/H 74 cm - P/D 120 cm L/W 110"1/4 - A/H 29"1/8 - P/D 47"1/4	L/W 280 cm - A/H 74 cm - P/D 120 cm L/W 110"1/4 - A/H 29"1/8 - P/D 47"1/4	L/W 200 cm - A/H 74 cm - P/D 100 cm L/W 78"3/4 - A/H 29"1/8 - P/D 39"3/8	L/W 200 cm - A/H 74 cm - P/D 100 cm L/W 78"3/4 - A/H 29"1/8 - P/D 39"3/8
ELITE0000304A	ELITE0000304B	ELITE0000305A	ELITE0000305B

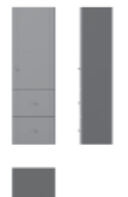
MOBILI ALTI CON ANTA / HIGH CABINETS WITH DOOR

			
L/W 56 cm - A/H 179 cm - P/D 42 cm L/W 22" - A/H 70"1/2 - P/D 16"1/2	L/W 56 cm - A/H 179 cm - P/D 42 cm L/W 22" - A/H 70"1/2 - P/D 16"1/2	L/W 56 cm - A/H 179 cm - P/D 42 cm L/W 22" - A/H 70"1/2 - P/D 16"1/2	L/W 56 cm - A/H 179 cm - P/D 42 cm L/W 22" - A/H 70"1/2 - P/D 16"1/2
ELITE0000308	ELITE0000309	ELITE0000310	ELITE0000311





MOBILI ALTI CON CASSETTI / HIGH CABINETS WITH DRAWERS

					
L/W 56 cm - A/H 179 cm - P/D 42 cm L/W 22" - A/H 70"1/2 - P/D 16"1/2	L/W 56 cm - A/H 179 cm - P/D 42 cm L/W 22" - A/H 70"1/2 - P/D 16"1/2	L/W 56 cm - A/H 179 cm - P/D 42 cm L/W 22" - A/H 70"1/2 - P/D 16"1/2	L/W 56 cm - A/H 179 cm - P/D 42 cm L/W 22" - A/H 70"1/2 - P/D 16"1/2	L/W 56 cm - A/H 179 cm - P/D 42 cm L/W 22" - A/H 70"1/2 - P/D 16"1/2	L/W 56 cm - A/H 179 cm - P/D 42 cm L/W 22" - A/H 70"1/2 - P/D 16"1/2
ELITE0000312	ELITE0000313	ELITE0000314	ELITE0000315	ELITE0000316	ELITE0000317

MOBILE A GIORNO / OPEN CABINET

L/W 122 cm - A/H 107 cm - P/D 44 cm L/W 48" - A/H 42"1/8 - P/D 17"3/8
ELITE0000318

TOP PER MOBILI ALTI / TOP FOR HIGH CABINETS

				
L/W 116 cm - A/H 3 cm - P/D 45 cm L/W 45"5/8 - A/H 1"1/4 - P/D 17"3/4	L/W 172 cm - A/H 3 cm - P/D 45 cm L/W 67"3/4 - A/H 1"1/4 - P/D 17"3/4	L/W 228 cm - A/H 3 cm - P/D 45 cm L/W 89"3/4 - A/H 1"1/4 - P/D 17"3/4	L/W 238 cm - A/H 3 cm - P/D 45 cm L/W 93"3/4 - A/H 1"1/4 - P/D 17"3/4	L/W 284 cm - A/H 3 cm - P/D 45 cm L/W 111"3/4 - A/H 1"1/4 - P/D 17"3/4
ELITE0000319	ELITE0000320	ELITE0000321	ELITE0000322	ELITE0000323

ELEMENTI PER ASSEMBLAGGIO / ELEMENTS FOR ASSEMBLY



L/W 61 cm - A/H 77 cm - P/D 40 cm
L/W 24" - A/H 30"3/8 - P/D 15"3/4

ELITE00000324



L/W 33 cm - A/H 77 cm - P/D 40 cm
L/W 13" - A/H 30"3/8 - P/D 15"3/4

ELITE00000325

MOBILI BASSI / LOW CABINETS



L/W 56 cm - A/H 72 cm - P/D 42 cm
L/W 22" - A/H 28"3/8 - P/D 16"1/2

ELITE00000326

ELITE00000327



L/W 56 cm - A/H 72 cm - P/D 42 cm
L/W 22" - A/H 28"3/8 - P/D 16"1/2

ELITE00000328

ELITE00000329



ELITE00000330



L/W 56 cm - A/H 72 cm - P/D 42 cm
L/W 22" - A/H 28"3/8 - P/D 16"1/2

ELITE00000331

TOP PER MOBILI BASSI / TOP FOR LOW CABINETS



L/W 238 cm - A/H 3 cm - P/D 45 cm
L/W 93"3/4 - A/H 1"1/4 - P/D 17"3/4

ELITE00000332



L/W 182 cm - A/H 3 cm - P/D 45 cm
L/W 71"5/8 - A/H 1"1/4 - P/D 17"3/4

ELITE00000333



L/W 122 cm - A/H 3 cm - P/D 45 cm
L/W 48" - A/H 1"1/4 - P/D 17"3/4

ELITE00000334

MOBILI BAR / BAR CABINETS



L/W 145 cm - A/H 103 cm - P/D 75-80 cm
L/W 57"1/8 - A/H 40"1/2 - P/D 29"1/2 - 31"1/2

ELITE00000335

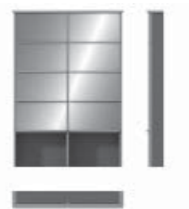

L/W 145 cm - A/H 203 cm - P/D 22 cm
L/W 57"1/8 - A/H 79"7/8 - P/D 8"5/8

ELITE00000336

RIPIANO / SHELF



L/W 52 cm - P/D 38 cm
L/W 20"1/2 - P/D 15"

ELITE00000340

TAVOLO COMPUTER / COMPUTER TABLE



L/W 90 cm - A/H 74 cm - P/D 60 cm
L/W 35"1/2 - A/H 29"1/8 - P/D 23"5/8

ELITE00000341

office

▶ TAVOLI RIUNIONE
CONFERENCE TABLES

 **Mariani**

226 **MASTER**
232 **LEADER**
238 **PRESIDENT**
248 **PAPIER**
254 **BIG**



▶ MASTER
DESIGN: UMBERTO ASNAGO



MASTER DESIGN: UMBERTO ASNAGO

Il modello è disponibile di serie esattamente come presentato, con dimensioni di 520x120 cm e finitura in cuoio abbinata a essenza di noce canaletto tinto grigio; la struttura inferiore è dotata di ante apribili, per consentire un facile accesso alla canalina d'acciaio di serie la quale connette fra loro le 8 scatole a scomparsa (ognuna delle quali contiene 2 prese di corrente universali, 2 USB, 1 Audio 3.5, 1 HDMI, 2 RJ45). I cavi sono esclusi.

Il piano è realizzato con pannello di particelle di legno 35 mm, rivestito in cuoio e con parte centrale impiallacciata; a questo piano è applicato un bordo sagomato in massello di noce canaletto tinto grigio. La base ha una struttura interna in nobilitato nero con spessore 20 mm; le ante sono in pannello di particelle di legno spessore 20 mm, impiallacciate e con sistema di apertura push & pull.

Naturalmente questo modello è completamente personalizzabile sia per dimensioni che per materiali che per accessori.

The model is available as standard exactly as presented, with dimensions of 520x120 cm and saddle leather finish combined with grey stained black walnut wood; the lower frame has doors that allow an easy access to the standard metal channel for wiring cables which connects the 8 boxes hidden in the top of the table (every box contains 2 universal power sockets, 2 USB, 1 Audio 3.5, 1 HDMI, 2 RJ45). The cables are not included.

The top is made of 35 mm thickness particleboard panel, covered in saddle leather and with a veneered central part; a shaped edge in grey stained black walnut solid wood is applied to this top. The base has an internal frame in black melamine coated panel with a thickness of 20 mm; the doors are in 20 mm thickness particleboard panel veneered and with push & pull opening system.

Obviously this model can be "tailor-made" for both dimensions, materials and accessories.

TAVOLI RIUNIONE / CONFERENCE TABLE

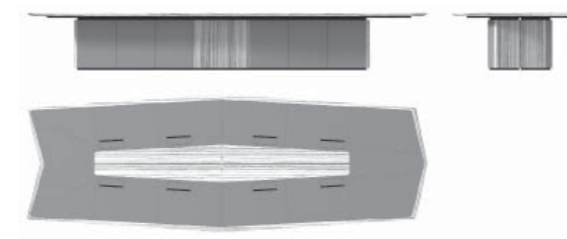

L/W 514 cm - A/H 73 cm - P/D 177 cm
L/W 202"3/8 - A/H 28"3/4 - P/D 69"5/8

MASTERTA520CC

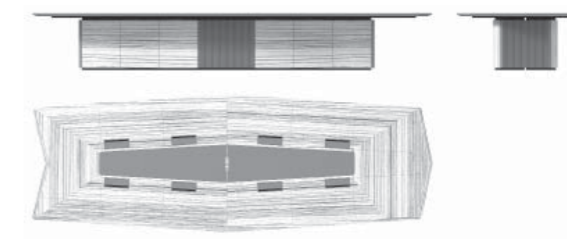

L/W 514 cm - A/H 73 cm - P/D 177 cm
L/W 202"3/8 - A/H 28"3/4 - P/D 69"5/8

MASTERTA520NG



Tanti i dettagli che rendono Master un valido strumento di lavoro: completamente canalizzato e ispezionabile, sul top ha 8 postazioni con prese elettriche e dati oltre alla possibilità di inserire un avanzato monitor a scomparsa a filo piano.

Many details make Master a valid working tool: completely prepared for cable passage under the top and ready for inspection, on the top it has 8 electrical boxes equipped with power and data sockets in addition to the possibility of inserting an advanced flush-mounted retractable monitor.



▶ LEADER

DESIGN: R&S | 4 MARIANI





Finiture: eucalipto e cuoio CF 06. Gambe verniciate con effetto cromato e inserto in pelle PF 4104.
 Finishings: eucalyptus wood and saddle leather CF 06. Legs varnishde with chromed effect and detail in leather PF 4104.

LEADER DESIGN: R&S | 4 MARIANI

Il modello è disponibile di serie esattamente come presentato, con dimensioni di 620x294 cm e finitura in essenza di eucalipto abbinata al cuoio.
 Il piano è realizzato con pannello di particelle di legno 35 mm, impiallacciato in essenza di eucalipto e con una striscia centrale rivestita in cuoio; lungo questa striscia sono incassate 10 scatole a scomparsa (ognuna delle quali contiene 2 prese di corrente universali, 2 USB, 1 Audio 3.5, 1 HDMI, 2 RJ45), mentre sotto alla stessa è fissata una canalina in acciaio per passaggio cavi; i cavi sono esclusi. Le gambe sono in trafilato di alluminio, curvate e verniciate con effetto cromato. Naturalmente questo modello è completamente personalizzabile sia per dimensioni che per materiali che per accessori.

*The model is available as standard exactly as presented, with dimensions of 620x294 cm and finish in eucalyptus wood combined with saddle leather.
 The top is made of 35 mm particleboard panel, veneered in eucalyptus wood and with a central stripe covered in saddle leather; along this stripe there are 10 boxes hidden in the top of the table (each of which contains 2 universal power sockets, 2 USB, 1 Audio 3.5, 1 HDMI, 2 RJ45), while a steel cable channel is fixed underneath it; cables are not included. The legs are made of drawn aluminum, folded and painted with a chrome effect varnish.
 Naturally this model is completely customizable both in size and in materials and accessories.*

TAVOLI RIUNIONE / CONFERENCE TABLE

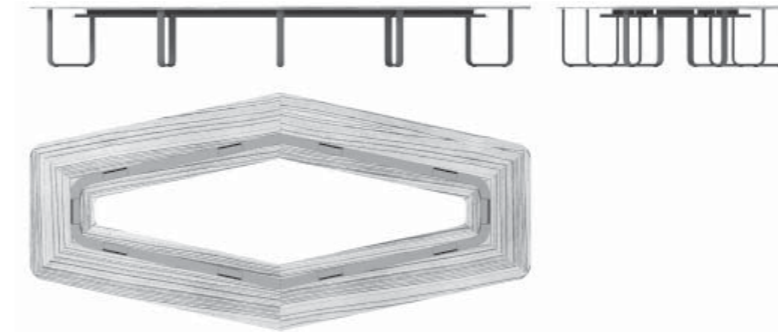

L/W 620 cm - A/H 75,5 cm - P/D 294 cm
 L/W 244"1/8 - A/H 29"3/4 - P/D 115"3/4

LEADERD620294



▶ PRESIDENT
DESIGN: R&S | 4 MARIANI









PRESIDENT DESIGN: R&S I 4 MARIANI

PRESIDENT è un tavolo conferenze di grande dimensione che rappresenta in maniera perfetta la flessibilità produttiva dell'azienda. È disponibile di serie esattamente come presentato, con dimensioni di 600 x 210 cm e finitura in cuoio abbinata a essenza tipo palissandro; la struttura inferiore è dotata di ante apribili, per consentire un facile accesso alla canalizzazione di serie la quale connette fra loro le 10 scatole a scomparsa (che contengono 2 prese elettriche, 1 connessione telefonica e 2 connessioni dati) e il meccanismo automatizzato di salita e discesa di uno schermo. I cavi sono esclusi.

Il piano è realizzato con pannello di particelle di legno 35 mm smussato, rivestito in cuoio e con parte centrale impiattata. La base ha una struttura interna in nobilitato nero con spessore 20 mm; le ante sono in pannello di particelle di legno spessore 20 mm, impiattate e con sistema di apertura push & pull.

Naturalmente questo modello è completamente personalizzabile sia per dimensioni che per materiali che per accessori.

PRESIDENT is a conference table with big dimensions that represent in a perfect way the flexibility of the Company. It is available exactly as presented, with dimension of 600 x 210 cm and finishing in saddle leather and rosewood type veneer; the lower frame has doors that allows a simple access to the metal channel for wiring cables that run all around the table and connect the 10 boxes hidden in the top of the table (every box contains 2 power sockets, 1 telephone socket and 2 data sockets) and the automatic mechanism of coming up and down of a display. Wires not included.

The top is made with black melamine coated panels 35 mm thickness with rounded edges, covered in saddle leather and a central inlay veneered. The frame base is in black melamine coated panels 20 mm thickness; the doors are in particleboard panel 20 mm thickness veneered and with push & pull opening system.

Obviously this model can be "tailor-made" for both dimensions, materials and accessories.

TAVOLI RIUNIONE / CONFERENCE TABLE

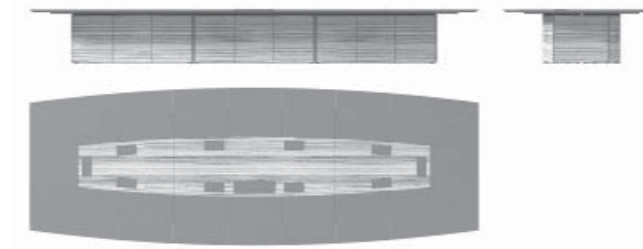

L/W 600 cm - A/H 72 cm - P/D 210 cm
L/W 236"1/4 - A/H 28"3/8 - P/D 82"5/8

PRESIDD600210



PAPIER

DESIGN: MATTEO NUNZIATI



Finiture: Cuoio CF 04.
 Finishings: Saddle Leather CF 04.



PAPIER DESIGN: MATTEO NUNZIATI

Il piano del tavolo è disponibile tondo o quadrato con finitura marmo calacatta oro (o qualsiasi altro marmo a collezione) o in pannello di particelle di legno impiallacciato in essenza tipo rovere naturale o moro. La colonna portante è costituita da due pannelli in multistrato di faggio curvato in stampo rivestiti in cuoio e fissati fra di loro, che poggiano a terra su una piastra d'acciaio di 10 mm di spessore verniciata nera e superiormente su un sottotop in nobilitato nero. Il mobile è costituito da pannelli in nobilitato rovere bianco spessore 19 mm fra i quali lo schienale e le ante sono laccate di colore nero finitura opaca su un solo lato. Il top, i fianchi, le gambe e le ante sono rivestite in cuoio. La maniglia curva è realizzata in massello di faggio laccata nera. La struttura della sedia è realizzata con un tubolare d'acciaio annegato in uno stampo di poliuretano schiumato a freddo con densità di 55 Kg/m³; tale prodotto nudo così ottenuto risulta ignifugo in Classe 1IM secondo la normativa vigente italiana e disponibile su richiesta e con sovrapprezzo per altre normative internazionali. Il basamento è costituito da una struttura in acciaio con 4 gambe alle quali sono incollate lastre di poliuretano espanso. La sedia è disponibile anche nella versione con piastre laterali in acciaio verniciato a polverio epossidiche di colore nero. La base ed il top dei tavolini sono realizzati da pannelli di MDF mentre il fianco è un pannello di multistrato di betulla curvato in stampo. Internamente sono laccati in colore nero opaco, mentre sui lati esterni e sul top sono rivestiti in cuoio.

The top of the table is available in round or square shape with finishing in marble Calacatta Oro (or any other marble available in Collection) or in particleboard panel veneered in wood similar to oak with natural or dark brown finishing. The central column is made by two round beech plywood panel curved into a mould and covered in saddle leather and fixed together; the column lean on a metal sheet 10 mm thickness black lacquered and support a subtop of black coated melamine panel.
The cabinet is made by melamine coated panels 19 mm with white oak finishing; the back and the doors are black lacquered on one side only. The top, sides and legs are covered in saddle leather. The curved handle is in solid beech wood black lacquered.
The frame of the chair is made in tubular steel embedded in a polyurethane cold formed in mould with density of 55 Kg/m³; this naked foam item comply to the Italian Classe 1IM fire resistant laws and is also available on demand and with extra rate for other international standards. The base is a steel frame with 4 legs covered by polyurethane foam sheets. The chair is also available with side steel elements black powder coating varnished.
The base and the top of the low tables are made in MDF fiberboard panels, while the side is in birch plywood panel curved into a mould. Internally they are black matt lacquered while outside they are covered in saddle leather.

TAVOLI / TABLES



L/W 150 cm - A/H 75,5 cm - P/D 150 cm
 L/W 59" - A/H 29" 5/7 - P/D 59"

PAPIERT150QCU



L/W 150 cm - A/H 75,5 cm - P/D 150 cm
 L/W 59" - A/H 29" 5/7 - P/D 59"

PAPIERT150QES

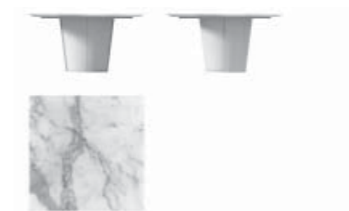

L/W 150 cm - A/H 75,5 cm - P/D 150 cm
 L/W 59" - A/H 29" 5/7 - P/D 59"

PAPIERT150QMA



Ø 150 cm - A/H 75,5 cm
 Ø 59" - A/H 29" 5/7

PAPIERT150TCU



Ø 150 cm - A/H 75,5 cm
 Ø 59" - A/H 29" 5/7

PAPIERT150TES



Ø 150 cm - A/H 75,5 cm
 Ø 59" - A/H 29" 5/7

PAPIERT150TMA



L/W 300 cm - A/H 75,5 cm - P/D 130 cm
 L/W 118" 1/8 - A/H 29" 5/7 - P/D 51" 1/5

PAPIERT300CU



L/W 300 cm - A/H 75,5 cm - P/D 130 cm
 L/W 118" 1/8 - A/H 29" 5/7 - P/D 51" 1/5

PAPIERT300ES

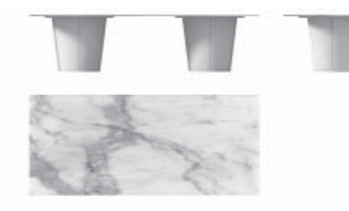

L/W 300 cm - A/H 75,5 cm - P/D 130 cm
 L/W 118" 1/8 - A/H 29" 5/7 - P/D 51" 1/5

PAPIERT300MA



▶ BIG

DESIGN: GUIDO FALESCHINI



Finiture: cuoio CF 01 e laminato nero.
Poltrone in cuoio CF 01 pelle PF 4105.
Finishings: saddle leather CF 01 and black laminate.
Armchairs in saddle leather CF 01 and leather PF 4105.



Una scelta per imporre la giusta importanza al proprio ambiente di lavoro e alla sala riunioni. I piani e le gambe delle scrivanie e dei tavoli riunione sono realizzati in pannello tamburato con bordi e traversi in massello di faggio, cartone a nido d'ape spessore 35 mm e due pannelli di mdf o di nobilitato nero da 10 mm sulle due facce. I bordi arrotondati sono sempre rivestiti in cuoio, mentre il top puo' essere in cuoio, in essenza di ciliegio, in cristallo verniciato nero oppure in laminato nero.

La struttura delle cassetiere e degli allunghi è in pannello nobilitato nero e puo' essere anche rivestita completamente in cuoio; il bordo del top e del basamento è sempre in cuoio mentre il top è in cuoio oppure in laminato nero. I frontali sono in pannello nobilitato nero rivestiti in cuoio oppure impiallacciati in essenza di ciliegio.

I mobili contenitori hanno un basamento in pannello tamburato con finitura in nobilitato nero e con il bordo rivestito in cuoio; la struttura ed il top sono realizzati in pannello nobilitato nero con spessore variabile nei diversi elementi da 8 mm a 30 mm. Il top dei mobili con h. 76 cm è rivestito completamente in cuoio oppure è in essenza di ciliegio con bordo in cuoio, mentre i mobili con h. 186 cm hanno il top in nobilitato nero con bordo in cuoio. E' possibile anche, su richiesta, avere la spalla laterale del mobile rivestita in cuoio. I mobili hanno un profilo verticale in tubolare metallico verniciato a polveri epossidiche di colore nero. I frontali delle ante e dei cassetti sono in pannello nobilitato nero e rivestiti in cuoio oppure in essenza di ciliegio oppure in cristallo fumè.

Le maniglie sono in acciaio verniciato a polveri epossidiche di colore nero.

Le poltrone hanno una struttura in multistrato di faggio rivestita in vellutino accoppiato. I cuscini di seduta e dei braccioli sono in poliuretano schiumato a freddo mentre quello dello schienale è in poliuretano espanso entrambi rivestiti con vellutino accoppiato. Le poltrone sono dotate di basculante e regolabili in altezza mediante pistone a gas. Il basamento è disponibile in una versione in poliuretano integrale nero schiumato a freddo o in alluminio lucidato o verniciato nero. I braccioli sono in acciaio cromato o verniciato nero a polveri epossidiche.

A selection that establishes the importance of the proper working environment and also of conference rooms.

The tops and the legs of the desks and conference tables are made of honeycomb fiberboard with edges and crossbars in beechwood, honeycomb material 35 mm. and two panels each 10mm with mdf or black melamine coating on the two faces. The round edges are always covered by saddle leather, while the top can be in saddle leather, veneered in cherry wood, in black varnished glass or in black laminate.

The frame of the pedestals and returns is in black melamine coated panel and can also be covered completely by saddle leather; the edge on the top and on the base is always in saddle leather while the top is in saddle leather or in black laminate. The fronts are in black melamine covered by saddle leather or veneered in cherry wood.

The filing cabinets have a base in honeycomb fiberboard with black melamine coating finish and the edge covered by saddle leather; the frame and the top are made in black melamine coated panels with thickness variable for the different elements from 8 mm. to 30 mm. On the 76 cm high cabinets the top is completely covered by saddle leather or veneered in cherry wood with the edges in saddle leather, while on the 186 cm high cabinets it is covered by saddle leather on the external edge only. The cabinets have a vertical profile in tubular metal varnished with black epoxy powder. The fronts of the doors and drawers are in black melamine coated panels and covered by saddle leather or veneered in cherry wood or in smoked glass. The handles are in steel varnished with black epoxy powder.

The armchair structures are in beechwood multi-ply panels covered by bonded plush. The seat and arm cushions are in cold formed polyurethane, while the back cushion is in polyurethane foam, both covered by bonded plush. The armchairs are equipped with tilt mechanism and are adjustable in height through a gas-piston. The base is available in black self skinning cold formed polyurethane or in polished aluminium or in black epoxy powder varnished.

TAVOLI RIUNIONE / CONFERENCE TABLES

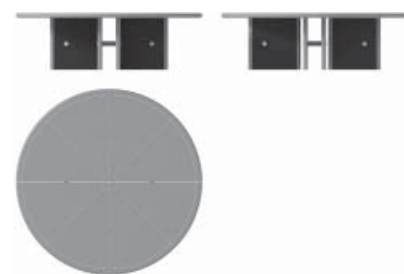

L/W 245 cm - A/H 74 cm - P/D 245 cm
L/W 96"1/2 - A/H 29"1/8 - P/D 96"1/2

BIG000DESK46C

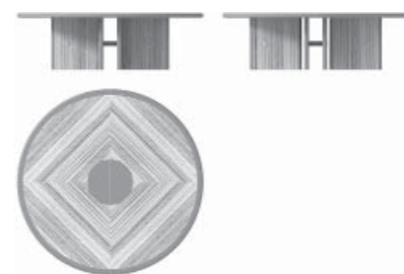

L/W 245 cm - A/H 74 cm - P/D 245 cm
L/W 96"1/2 - A/H 29"1/8 - P/D 96"1/2

BIG000DESK46E

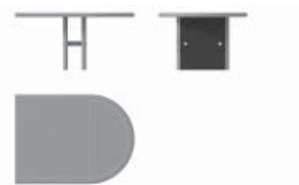

L/W 155,5 cm - A/H 74 cm - P/D 116 cm
L/W 61"1/4 - A/H 29"1/8 - P/D 45"5/8

BIG000DESK47C



L/W 155,5 cm - A/H 74 cm - P/D 116 cm
L/W 61"1/4 - A/H 29"1/8 - P/D 45"5/8

BIG000DESK47E



L/W 150 cm - A/H 74 cm - P/D 116 cm
L/W 59" - A/H 29"1/8 - P/D 45"5/8

BIG000DESK48C



L/W 150 cm - A/H 74 cm - P/D 116 cm
L/W 59" - A/H 29"1/8 - P/D 45"5/8

BIG000DESK48E

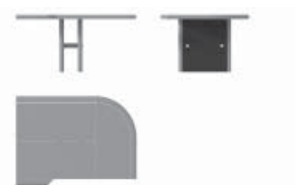

L/W 157 cm - A/H 74 cm - P/D 116 cm
L/W 61"3/4 - A/H 29"1/8 - P/D 45"5/8

BIG000DESK49C



L/W 157 cm - A/H 74 cm - P/D 116 cm
L/W 61"3/4 - A/H 29"1/8 - P/D 45"5/8

BIG000DESK49E

TAVOLI RIUNIONE / CONFERENCE TABLES

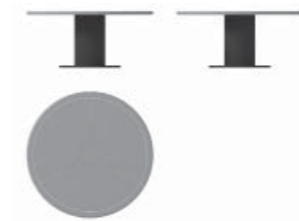

L/W 165 cm - A/H 74 cm - P/D 165 cm
L/W 65" - A/H 29"1/8 - P/D 65"

BIG000DESK81C

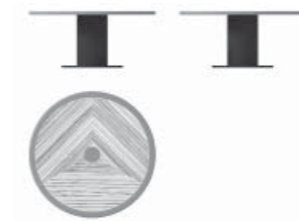

L/W 165 cm - A/H 74 cm - P/D 165 cm
L/W 65" - A/H 29"1/8 - P/D 65"

BIG000DESK81E

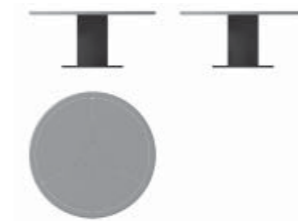

L/W 165 cm - A/H 74 cm - P/D 165 cm
L/W 65" - A/H 29"1/8 - P/D 65"

BIG000DESK82C

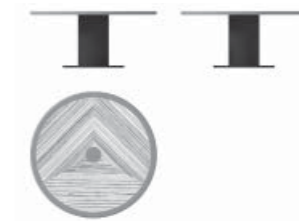

L/W 165 cm - A/H 74 cm - P/D 165 cm
L/W 65" - A/H 29"1/8 - P/D 65"

BIG000DESK82E



L/W 220 cm - A/H 74 cm - P/D 100 cm
L/W 86"5/8 - A/H 29"1/8 - P/D 39"3/8

BIG000DESK83C



L/W 220 cm - A/H 74 cm - P/D 100 cm
L/W 86"5/8 - A/H 29"1/8 - P/D 39"3/8

BIG000DESK83E

POLTRONE / ARMCHAIRS



L/W 80 cm - A/H 124-131 cm - a/h 48-55 cm - P/D 72 cm
L/W 31"1/2 - A/H 48"3/4-51"1/2 cm - a/h 18"7/8-21"5/8 - P/D 28"3/8

BIG000POLT025



L/W 69 cm - A/H 93-100 cm - a/h 48-55 cm - P/D 70 cm
L/W 27"1/8 - A/H 36"5/8-39"3/8 cm - a/h 18"7/8-21"5/8 - P/D 27"1/2

BIG000POLT026

office

► POLTRONE PER UFFICIO
OFFICE ARMCHAIRS

 **Mariani**

264	GARBO
266	KEFA
267	SILHOUETTE
268	WING
270	BLADE
271	SHU - VOILE
272	ARES
273	GINZA
274	LUX
275	LOOP
276	CASSANDRA
277	BIG
278	HOPY
279	TUCROMA



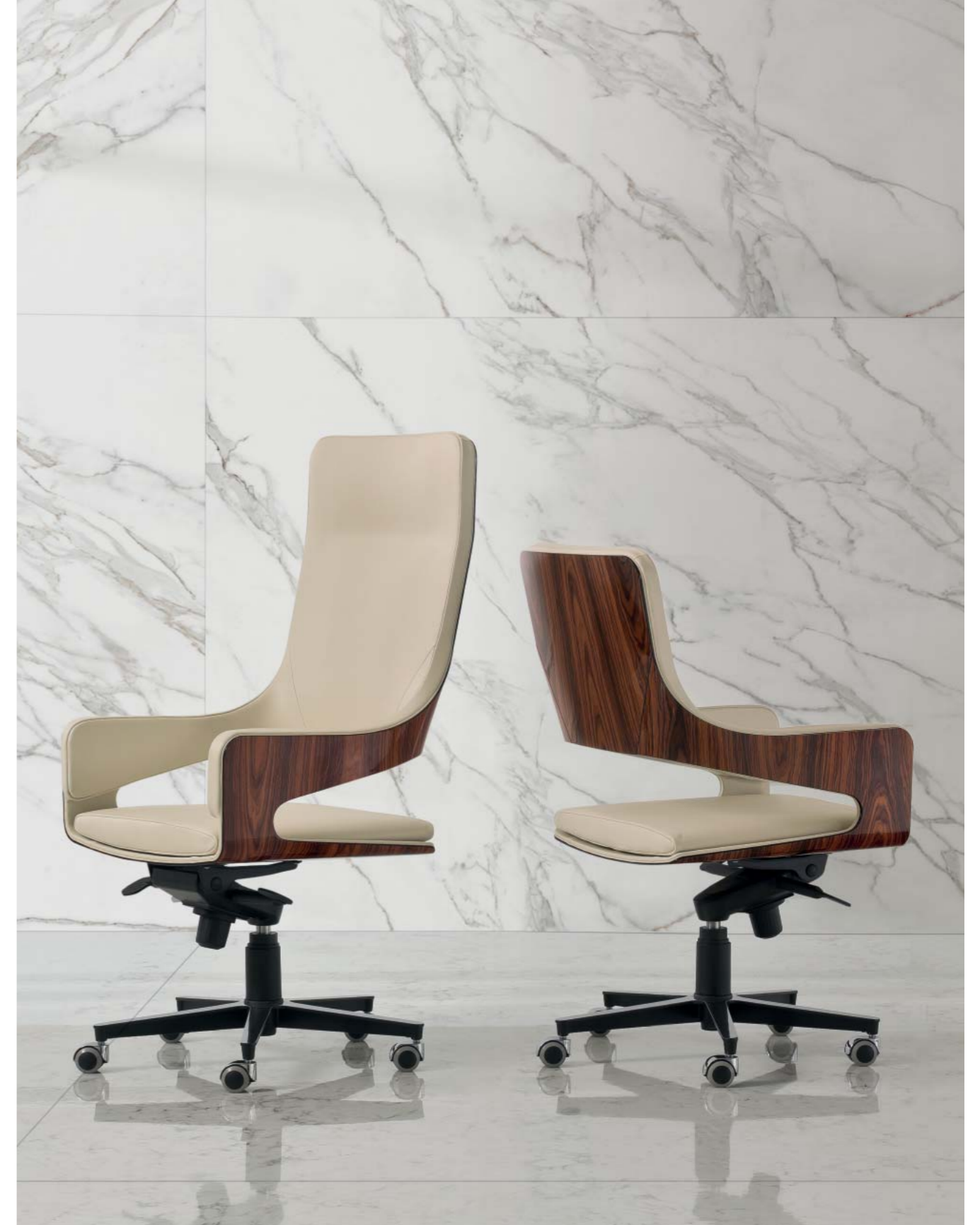

Cuoio / Cuoio.
Saddle leather / Saddle leather.



Cuoio / Essenza.
Saddle leather / Wood.



Pelle / Pelle.
Leather / Leather.

Pelle / Laccatura.
Leather / Lacquering.













ARES DESIGN: LUCA SCACCHETTI

Le poltrone hanno una unica struttura per seduta, braccioli e schienale basso comune a tutte le poltroncine realizzata in tubolare d'acciaio e rivestita con poliuretano espanso con densità di 50 kg/m³ e poi ancora con vellutino accoppiato. La poltrona direzionale alta e conferenza media sono poi dotate di uno schienale aggiuntivo sempre con struttura in acciaio e rivestimento in poliuretano espanso (50 kg/m³) e vellutino accoppiato. Le poltrone hanno un basamento a 5 razze in alluminio pressofuso in una delle tre finiture disponibili (lucidato o verniciato silver o verniciato ottone opaco) e sono girevoli, regolabili in altezza tramite pistone a gas e dotate di meccanismo basculante. La poltrona a pozzetto è disponibile anche con un basamento a croce in acciaio in una delle tre finiture con pistone con meccanismo di ritorno.

Nella collezione è disponibile anche una lampada da terra con fusto in legno massello di pioppo incamiciato da 5 mm. di MDF e impiallacciato in una delle tre essenze oppure rivestito in cuoio. Le parti metalliche hanno le 3 finiture disponibili e il cristallo è in finitura acidato.

The armchair have a unique frame for the seat, the arms and the low back (in common for all the armchairs); it is made by a tubular steel and covered by polyurethane foam with density of 50 kg/m³ and then with bonded plush.

The high executive armchair and the middle height conference armchair are then equipped by an extra back, always with steel frame, covering in polyurethane foam (50kg/m³) and bonded plush. The armchairs have a 5 star swivel base in pressure die-cast aluminium in one of the three finishes available (polished or silver painted or matte brass painted), height adjustable through a gas-piston and are equipped by a tilt mechanism. The conference tub armchair is also available with a cross steel base in one of the three finishes and with a recovery mechanism piston.

In the collection is also available a floor lamp with frame in solid poplar wood covered by mm 5 of MDF and veneered with one of the three woods finishes or covered by saddle leather. The metal parts have the three available finishes and the glass have an acid-etched finish.

POLTRONE / ARMCHAIRS



L/W 69 cm - A/H 111-119 cm - a/h 48-54 cm - P/D 66,5 cm
L/W 27"1/8 - A/H 43"3/4-46"7/8 cm - a/h 18"7/8-21"1/4 - P/D 26"1/4

ARES00POL1250



L/W 69 cm - A/H 97-105 cm - a/h 48-54 cm - P/D 66,5 cm
L/W 27"1/8 - A/H 38"1/4-41"3/8 cm - a/h 18"7/8-21"1/4 - P/D 26"1/4

ARES00POL1251



L/W 64 cm - A/H 79-87 cm - a/h 48-54 cm - P/D 65,5 cm
L/W 25"1/4 - A/H 31"1/8-34"1/4 cm - a/h 18"7/8-21"1/4 - P/D 25"3/4

ARES00POL1252

BIG DESIGN: GUIDO FALESCHINI

Le poltrone hanno una struttura in multistrato di faggio rivestita in vellutino accoppiato. I cuscini di seduta e dei braccioli sono in poliuretano schiumato a freddo mentre quello dello schienale è in poliuretano espanso entrambi rivestiti con vellutino accoppiato. Le poltrone sono dotate di basculante e regolabili in altezza mediante pistone a gas. Il basamento è disponibile in una versione in poliuretano integrale nero schiumato a freddo o in alluminio lucidato o verniciato nero. I braccioli sono in acciaio cromato o verniciato nero a polveri epossidiche.

The armchair structures are in beechwood multi-ply panels covered by bonded plush. The seat and arm cushions are in cold formed polyurethane, while the back cushion is in polyurethane foam, both covered by bonded plush. The armchairs are equipped with tilt mechanism and are adjustable in height through a gas-piston. The base is available in black self skinning cold formed polyurethane or in polished aluminium or in black epoxy powder varnished.

POLTRONE / ARMCHAIRS



L/W 80 cm - A/H 124-131 cm - a/h 48-55 cm - P/D 72 cm
L/W 31"1/2 - A/H 48"3/4-51"1/2 cm - a/h 18"7/8-21"5/8 - P/D 28"3/8

BIG000POLT025



L/W 69 cm - A/H 93-100 cm - a/h 48-55 cm - P/D 70 cm
L/W 27"1/8 - A/H 36"5/8-39"3/8 cm - a/h 18"7/8-21"5/8 - P/D 27"1/2

BIG000POLT026

BLADE DESIGN: MATTEO NUNZIATI

Le poltrone hanno una struttura in tubolare d'acciaio diametro 25 mm e spessore 1,5 mm nella sola versione cromata. Il sostegno è garantito da una rete di tessuto tecnico in PE disponibile in colore bianco o nero opportunamente cucita e calzata su due tondini di acciaio spessore 10 mm curvati e fissati al tubolare della struttura tramite opportune viti a testa svasata. Nel caso di rivestimento in pelle o tessuto la rete di tessuto tecnico viene cucita al tessuto o pelle accoppiati ad un vellutino ed in seguito calzata sui tondini e fissata alla struttura. Le poltrone sono dotate di basculante e sono regolabili in altezza mediante pistone a gas. Il basamento è a 5 razze in alluminio pressofuso lucido nella parte superiore e verniciato nero in quella inferiore. Esiste anche un basamento fisso in acciaio cromato e 4 razze.

The armchairs have a chromed steel tubular frame diam. 25 mm and thickness 1,5 mm. The support is guaranteed by a technical mesh fabric in PE available white or black colour, sewed and inserted on two iron rod thickness 10 mm, curved and fixed to the frame through appropriate countersunk screws. In case of upholstery in leather or fabric the technical mesh fabric is sewn to the fabric or leather combined to bonded plush and then inserted on the two iron rod fixed to the frame. The armchairs are equipped with swivel tilt and gas-lift mechanism. The base in pressure die cast aluminium is polished on the upper portion and black lacquered on the lower one. Fixed steel chromed base at 4 points is also available.

POLTRONE / ARMCHAIRS



L/W 51 cm - A/H 107-113 cm - a/h 42-48 cm - P/D 53 cm
L/W 20"1/8 - A/H 42"1/8-44"1/2 cm - a/h 16"1/2-18"7/8 - P/D 20"7/8

BLADE0POL1470



L/W 51 cm - A/H 91-98 cm - a/h 42-48 cm - P/D 53 cm
L/W 20"1/8 - A/H 35"3/4-38"1/2 cm - a/h 16"1/2-18"7/8 - P/D 20"7/8

BLADE0POL1471



L/W 51 cm - A/H 107-113 cm - a/h 42-48 cm - P/D 53 cm
L/W 20"1/8 - A/H 42"1/8-44"1/2 cm - a/h 16"1/2-18"7/8 - P/D 20"7/8

BLADE0POL1472



L/W 51 cm - A/H 91-98 cm - a/h 42-48 cm - P/D 53 cm
L/W 20"1/8 - A/H 35"3/4-38"1/2 cm - a/h 16"1/2-18"7/8 - P/D 20"7/8

BLADE0POL1473



L/W 51 cm - A/H 110 cm - a/h 48 cm - P/D 53 cm
L/W 20"1/8 - A/H 43"1/4 cm - a/h 18"7/8 - P/D 20"7/8

BLADE0POL1474



L/W 51 cm - A/H 98 cm - a/h 48 cm - P/D 53 cm
L/W 20"1/8 - A/H 38"1/2 cm - a/h 18"7/8 - P/D 20"7/8

BLADE0POL1475



L/W 51 cm - A/H 110 cm - a/h 48 cm - P/D 53 cm
L/W 20"1/8 - A/H 43"1/4 cm - a/h 18"7/8 - P/D 20"7/8

BLADE0POL1476



L/W 51 cm - A/H 98 cm - a/h 48 cm - P/D 53 cm
L/W 20"1/8 - A/H 38"1/2 cm - a/h 18"7/8 - P/D 20"7/8

BLADE0POL1477



L/W 46 cm - A/H 88-98 cm - a/h 46-56 cm - P/D 56,5 cm
L/W 18"1/8 - A/H 34"5/8-38"1/2 cm - a/h 18"1/8"-22 - P/D 21"1/4

BEVERLUFFCUOI



L/W 46 cm - A/H 88-98 cm - a/h 46-56 cm - P/D 56,5 cm
L/W 18"1/8 - A/H 34"5/8-38"1/2 cm - a/h 18"1/8"-22 - P/D 21"1/4

BEVERLUFFIMBO



L/W 46 cm - A/H 88-98 cm - a/h 46-56 cm - P/D 56,5 cm
L/W 18"1/8 - A/H 34"5/8-38"1/2 cm - a/h 18"1/8"-22 - P/D 21"1/4

BEVERLUFFLACC

CASSANDRA

DESIGN: LUCA SCACCHETTI

La struttura della poltrona è realizzata con un tubolare quadro d'acciaio annegata in uno stampo di poliuretano schiumato a freddo con densità di 60 Kg/m³; tale prodotto nudo così ottenuto risulta ignifugo in Classe 11M secondo la normativa vigente italiana e disponibile su richiesta e con sovrapprezzo per altre normative internazionali. Sullo schienale viene incollata una lastra di ovatta poliesteri mentre il cuscino della seduta è in poliuretano espanso rivestito da ovatta poliesteri.

Il basamento è disponibile in 3 tipologie: tubolare tondo con 4 razze girevole in acciaio cromato o verniciato; struttura in tubolare d'acciaio con 4 gambe verniciato a polveri epossidiche nei colori disponibili in collezione; per la versione da ufficio basamento girevole a 5 razze su ruote in alluminio lucidato, regolabile in altezza tramite pistone a gas e dotate di basculante.

POLTRONE / ARMCHAIRS



L/W 76 cm - A/H 122-130 cm - a/h 46-54 cm - P/D 77 cm
L/W 29"7/8 - A/H 48"-51"1/4 cm - a/h 18"1/8-21"1/4 - P/D 30"1/8

CASSANPOLTUFF

The frame of the armchair is made in square section tubular steel embedded in a polyurethane cold formed in mould with density of 60 Kg/m³; this naked foam item comply to the Italian Classe 11M fire resistant laws and is also available on demand and with extra rate for other international standards. On the back is glued a sheet of polyester wadding; the seat cushion is made in polyurethane foam covered by polyester wadding.

The base is available in 3 different kind: round tubular swivel base with 4 star in chromed steel; tubular base with 4 legs epoxy powder varnished in the available colours of the collection; for the office version, a 5 star swivel base on casters in polished aluminium adjustable in height through a gas-piston and equipped by tilt mechanism.

GARBO

DESIGN: UMBERTO ASNAGO

La struttura della poltrona è costituita da due parti di multistrato di faggio curvati in stampo, uno per la seduta ed uno per lo schienale, uniti fra di loro tramite un elemento di congiunzione in massello di faggio e due piastre in acciaio.

L'imbottitura dello schienale è realizzata in poliuretano espanso schiumato a freddo in stampo e incollata ad un sottile pannello di multistrato che poi viene ulteriormente fissato allo struttura dello schienale. Il cuscino della seduta è realizzato in poliuretano espanso rivestito da ovatta poliesteri.

Il basamento è costituito da un tubolare tondo con 4 razze girevole in acciaio cromato lucido o cromato nero.

The frame of the relax armchair is composed by two pieces of beech plywood panel curved into a mould, one for the back and one for the seat, fixed together through a solid beech wood part and two metal sheets.

The cushion of the back is a piece of polyurethane cold formed into a mould glued to a thin plywood panel that is fixed to the frame of the back. The seat cushion is made in polyurethane foam covered in polyester wadding.

Both the armchair and the ottoman have a round tubular steel with 4 star swivel base available in chromed steel or black chromed steel.

POLTRONE UFFICIO / OFFICE ARMCHAIRS



L/W 69 cm - A/H 122-131 cm - a/h 52-61 cm - P/D 75 cm
L/W 27"1/8 - A/H 48"-51"1/2 cm - a/h 20"1/2-24" - P/D 29"1/2

GARBO0POL011M

GARBO0POL01ES

GARBO0POL01LA



L/W 68 cm - A/H 100-109 cm - a/h 52-61 cm - P/D 72 cm
L/W 26"3/4 - A/H 39"3/8-42"7/8 cm - a/h 20"1/2-24" - P/D 28"3/8

GARBO0POL021M

GARBO0POL02ES

GARBO0POL02LA



L/W 63 cm - A/H 87-96 cm - a/h 53-62 cm - P/D 71 cm
L/W 24"3/4 - A/H 34"1/4-37"3/4 cm - a/h 20"7/8-24"3/8 - P/D 28"

GARBO0POL031M

GARBO0POL03ES

GARBO0POL03LA

GINZA

DESIGN: PIERLUIGI MOLINARI

La serie è composta da poltrona direzionale e conferenza su base con ruote a 5 razze e da sedie con due gambe e due ruote inserite nella spalliera. La struttura dello schienale è in tubolare ovale d'acciaio accoppiata a lastre di poliuretano espanso e in seguito rivestita in cuoio. I braccioli sono in piatto d'acciaio curvato, accoppiato a lastre di poliuretano espanso e rivestiti in cuoio. La seduta ha un inserto in tubolare d'acciaio annegato in uno stampo di poliuretano schiumato a freddo; il cuscino dello schienale è in poliuretano schiumato a freddo. Le poltrone hanno un basamento a 5 razze in alluminio spazzolato e sono girevoli, regolabili in altezza tramite pistone a gas e dotate di meccanismo basculante. Le gambe delle sedie sono in acciaio cromato.

Series includes executive and conference armchairs with a 5 star swivel base on caster, and chairs with or without arms with two legs and two casters inserted on the back. The back frame is in tubular steel covered by polyurethane foam sheet and then covered by saddle leather. The curved steel plate arms are covered with a polyurethane foam sheet and then covered by saddle leather. The seat has a tubular steel frame embedded in cold formed polyurethane; the cushion of the back is made by a cold formed polyurethane. The 5 star swivel base on caster is in polished aluminium.

POLTRONE UFFICIO / OFFICE ARMCHAIRS



L/W 68 cm - A/H 107-115 cm - a/h 48-56 cm - P/D 70 cm
L/W 26"3/4 - A/H 42"1/8 - 45"1/4 cm - a/h 18"7/8-22" - P/D 27"1/2

GINZA000CS740
GINZA000CF740
GINZA000CV740



L/W 68 cm - A/H 93-99 cm - a/h 48-56 cm - P/D 70 cm
L/W 26"3/4 - A/H 36"5/8-39" cm - a/h 18"7/8-22" - P/D 27"1/2

GINZA000CS741
GINZA000CF741
GINZA000CV741



L/W 56 cm - A/H 88 cm - a/h 46 cm - P/D 62 cm
L/W 22" - A/H 34"5/8 cm - a/h 18"1/8 - P/D 24"3/8

GINZA000CS746
GINZA000CF746
GINZA000CV746



L/W 56 cm - A/H 88 cm - a/h 46 cm - P/D 62 cm
L/W 22" - A/H 34"5/8 cm - a/h 18"1/8 - P/D 24"3/8

GINZA000CS747
GINZA000CF747
GINZA000CV747

OPHI

DESIGN: UMBERTO ASNAGO

La poltroncina è disponibile su ruote o su scivoli in massello di noce canaletto, con rivestimento interamente in tessuto o in pelle o in entrambe. Altre finiture disponibili solo su richiesta. La struttura dello schienale è costituita da multistrato di faggio curvato in stampo mentre la seduta ha una struttura in acciaio con molleggio realizzato tramite cinghie elastiche. Entrambe sono imbottiti con lastre di poliuretano espanso con densità differenziate (20÷25 Kg/m³), sagomate e rivestite da ovatta poliesteri.

The armchair is available on wheels or on slides in massive Black Walnut wood, with a covering completely in fabric or in leather or in both. Other finishes available only on request. The frame of the back is made of beech plywood curved in a mold while the seat has a steel frame with webbing made of elastic belts. Both are padded with polyurethane foam sheets with different densities (20 ÷ 25 Kg/m³) shaped and covered with polyester wadding.

POLTRONE UFFICIO / OFFICE ARMCHAIRS



L/W 56 cm - A/H 77 cm - a/h 45 cm - P/D 65 cm
L/W 22" - A/H 30"3/8 cm - a/h 17"3/4 - P/D 25"5/8

OPHI00POLTR01



L/W 56 cm - A/H 77 cm - a/h 45 cm - P/D 65 cm
L/W 22" - A/H 30"3/8 cm - a/h 17"3/4 - P/D 25"5/8

OPHI00POLTR02



L/W 56 cm - A/H 77 cm - a/h 45 cm - P/D 65 cm
L/W 22" - A/H 30"3/8 cm - a/h 17"3/4 - P/D 25"5/8

OPHI00SEDIA01



L/W 56 cm - A/H 77 cm - a/h 45 cm - P/D 65 cm
L/W 22" - A/H 30"3/8 cm - a/h 17"3/4 - P/D 25"5/8

OPHI00SEDIA02

KEFA DESIGN: MATTEO NUNZIATI

Le poltrone hanno una struttura per la seduta ed i braccioli separata da quella dello schienale e costituita da un tubolare d'acciaio; entrambe sono annegate in uno stampo di poliuretano schiumato a freddo con densità di 60 Kg/m³; tale prodotto nudo così ottenuto risulta ignifugo in Classe 11M secondo la normativa vigente italiana e disponibile su richiesta e con sovrapprezzo per altre normative internazionali. Le poltrone hanno un basamento a 5 razze in alluminio pressofuso verniciato colore titanio e sono girevoli, regolabili in altezza tramite pistone a gas e dotate di meccanismo ergonomico.

The armchairs have the frame for the seat and for the arms separated from the backrest frame. Both have a frame in tubular steel embedded in a polyurethane cold formed in mould with density of 60 Kg/m³; this naked foam item comply to the Italian Classe 11M fire resistant laws and is also available on demand and with extra rate for other international standards. The base is available in a 5 star swivel base on casters in aluminum titanium color varnished; armchairs are adjustable in height through a gas-piston and equipped with an ergonomic mechanism.

POLTRONE / ARMCHAIRS

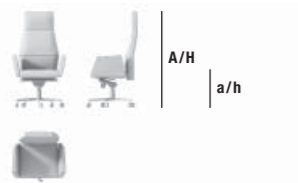

L/W 71 cm - A/H 125-132 cm - a/h 48-55 cm - P/D 61 cm
L/W 28" - A/H 49"1/4-52" cm - a/h 18"7/8-21"5/8 - P/D 24"

KEFA00POL1770



L/W 71 cm - A/H 102-109 cm - a/h 48-55 cm - P/D 61 cm
L/W 28" - A/H 40"1/8-42"7/8 cm - a/h 18"7/8-21"5/8 - P/D 24"

KEFA00POL1771

LOOP DESIGN: PIERLUIGI MOLINARI

La poltrona direzionale, conferenza e la sedia hanno una struttura costituita da una seduta e uno schienale in tubolare ovale d'acciaio annegata in uno stampo di poliuretano schiumato a freddo; la direzionale è anche dotata di cuscino poggiatesta in poliuretano espanso. I braccioli sono in acciaio curvato e rivestiti completamente in cuoio. Le poltrone hanno un basamento a 5 razze in alluminio spazzolato e sono girevoli, regolabili in altezza tramite pistone a gas e dotate di meccanismo basculante. Le gambe delle sedie sono in acciaio verniciato di colore nero a polveri epossidiche.

La struttura perimetrale dello scaffale è in pannello nobilitato nero completamente rivestito in cuoio (nella versione bifronte) oppure rivestita solamente sul fronte e sui fianchi (nella versione in appoggio a muro). I ripiani sono in pannello di particelle di legno impiallacciati in essenza di noce nazionale, mogano, ciliegio, noce canaletto o acero.

The executive and conference armchair and the visitor chair frame is composed by two different pieces: there is a seat and a back steel tubular frame embedded in a cold formed polyurethane; the executive armchair has also a polyurethane headrest cushion. The arms are in curved tubular steel completely covered by saddle leather. The armchairs have a 5 star swivel base on casters in polished aluminium, and are adjustable in height through a gas-piston and equipped by a tilt mechanism. The visitor chair legs are in steel black epoxy powder varnished. The bookcase frame is in black melamine coated panel completely covered by saddle leather (for the two faced bookcase) or covered only on the fronts and on the sides (for the one faced bookcase). The shelves are in particleboard panels veneered in Italian walnut, mahogany, cherry wood, black walnut or maple.

POLTRONE / ARMCHAIRS



L/W 57 cm - A/H 119-126 cm - a/h 53-60 cm - P/D 61 cm
L/W 22"1/2 - A/H 46"7/8-49"5/8 cm - a/h 20"7/8-23"5/8 - P/D 24"

LOOP000000650



L/W 57 cm - A/H 87-95 cm - a/h 47-54 cm - P/D 58 cm
L/W 22"1/2 - A/H 34"1/4-37"3/8 cm - a/h 18"1/2-21"1/4 cm - P/D 22"7/8"

LOOP000000651



L/W 57 cm - A/H 87-95 cm - a/h 47-54 cm - P/D 58 cm
L/W 22"1/2 - A/H 34"1/4-37"3/8 cm - a/h 18"1/2-21"1/4 cm - P/D 22"7/8"

LOOP00000651B

SCAFFALE / BOOKSHELV

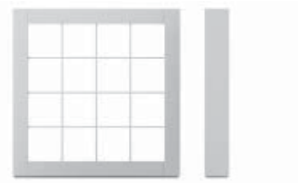

L/W 218 cm - A/H 220 cm - P/D 32 cm
L/W 85"3/4 - A/H 86"5/8 cm - P/D 12"5/8

LOOP000000668

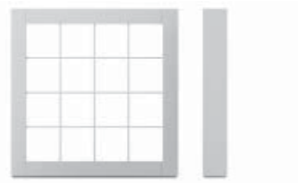

L/W 218 cm - A/H 220 cm - P/D 32 cm
L/W 85"3/4 - A/H 86"5/8 cm - P/D 12"5/8

LOOP000000669

LUX DESIGN: GUIDO FALESCHINI

La poltrona direzionale e conferenza hanno una struttura in tubolare tondo d'acciaio annegata in uno stampo di poliuretano schiumato a freddo. Su questa è fissata una materassina di poliuretano espanso ricoperto da ovatta poliesteri. I braccioli sono in acciaio curvato e cromato mentre nella parte superiore sono imbottiti con una lastra di poliuretano espanso ed in seguito rivestiti in cuoio. Le poltrone hanno un basamento a 5 razze in alluminio spazzolato e sono girevoli, regolabili in altezza tramite pistone a gas e dotate di meccanismo ergonomico – per la direzionale – o basculante – per la conferenza.

The executive and conference armchairs frame is in tubular steel embedded in a cold formed polyurethane and on it is fixed a polyurethane foam mat covered by polyester wadding. The chromed steel arms are padded on the upper part with a polyurethane foam sheet and then covered by saddle leather. The armchairs have a 5 star swivel base on casters in polished aluminium and are adjustable in height through a gas-piston and are equipped by an ergonomic mechanism (executive armchair) or tilt mechanism (conference armchair).



L/W 72 cm - A/H 112-119 cm - a/h 53-59 cm - P/D 70 cm
L/W 28"3/8 - A/H 44"1/8-46"7/8 cm - a/h 20"7/8-23"1/4 - P/D 27"1/2"

LUX0000000737



L/W 62 cm - A/H 97-102 cm - a/h 52-57 cm - P/D 70 cm
L/W 24"3/8 - A/H 38"1/4-40"1/8 cm - a/h 20"1/2-22"1/2 - P/D 27"1/2"

LUX0000000736

SHU – VOILE DESIGN: ALESSANDRO DUBINI

Il modello è disponibile solo in cuoio. Basamento disponibile: 4 gambe in noce canaletto finitura a cera oppure verniciato opaco in uno dei colori RAL a collezione; 4 gambe in tubolare quadro d'acciaio cromato lucido o nero; basamento girevole a 5 razze su ruote in alluminio lucidato, regolabile in altezza tramite pistone a gas e dotate di basculante.

La seduta è un pannello di multistrato di faggio imbottito con una lastra di poliuretano espanso rivestito in cuoio; nella versione poltrona da ufficio invece la seduta è in tubolare quadro d'acciaio rivestito in cuoio. Lo schienale ha una struttura in tondino d'acciaio curvato rivestita da entrambi i lati in cuoio e con una lastra di poliuretano espanso nel mezzo.

The model is available only in saddle leather. The base is available: 4 legs in solid black walnut wood with matt finishing "wax effect" or varnished in one of the RAL colours of the collection; 4 legs in square section tubular steel chromed polished or black effect; 5 star swivel base on casters in polished aluminum adjustable in height through a gas-piston and equipped by tilt mechanism.

The seat frame is a beech plywood panel upholstered with a sheet of polyurethane foam covered in saddle leather; in the office chair version the seat frame is in square section tubular steel covered in saddle leather. The back has a frame in steel rod curved and covered on both sides with saddle leather and with a sheet of polyurethane foam in the middle.

SHU – POLTRONA / ARMCHAIR



L/W 50 cm - A/H 85,5-94,5 cm - a/h 46,5-55,5 cm - P/D 57 cm
L/W 19"5/8 - A/H 33"5/8-37"1/4 cm - a/h 18"1/4-21"7/8 cm - P/D 22"1/2"

SHU000POLTRCU

VOILE – POLTRONA / ARMCHAIR



L/W 51,5 cm - A/H 77,5 - 86 cm - a/h 45,5 - 54 cm - P/D 53,5 cm
L/W 20"1/4 - A/H 30"1/2 - 33"7/8 cm - a/h 17"7/8 - 21"1/4 cm - P/D 21"1/8"

SHU000POLTRCU

SILHOUETTE

DESIGN: LUCA SCACCHETTI

Le poltrone direzionali, conferenza e a pozzetto hanno una struttura costituita da diversi elementi (sedile, schienale e braccioli) di multistrato di faggio curvati in stampo e uniti fra di loro tramite un opportuno incastro con fresatura articolata a doppia S.

L'imbottitura dal lato interno è realizzata tramite poliuretano espanso indeformabile ed esente da CFC schiumato a freddo in opportuni stampi e applicato a sua volta a uno strato di poliuretano Baydur 60 opportunamente sagomato in stampo. Questi vengono a loro volta incollati alla struttura in multistrato con colla poliuretanica bi-componente.

Il lato interno della seduta è sempre rivestito in pelle o tessuto. Il lato esterno invece ha diverse alternative:

- Rivestito in pelle o tessuto con una leggera imbottitura con una sottile lastra di poliuretano espanso indeformabile ed esente da CFC.
- Impiallacciato in essenza di lati o tipo ebano.
- Laccato opaco in colore bianco, nero oppure RAL 1019

Il sedile è dotato di un cuscinetto in poliuretano espanso indeformabile ed esente da CFC completamente rivestito in pelle o tessuto.

Le poltrone sono girevoli, regolabili in altezza con elevazione a gas e sono dotate di meccanismo basculante; la base è a 5 razze in alluminio pressofuso lucida nella parte superiore e verniciata nera in quella inferiore.

Esistono anche due diversi basamenti:

- Basamento in tubolare cromato a 4 razze.
- Basamento in tubolare con piatto tondo cromati.

E' disponibile anche un basamento per poltroncina bancone bar.

These executive, conference, and tub style arm chairs have a frame consisting of different elements. The seat, back, and arm rests are made of multi-ply beech wood, formed in a mould and joined together by an appropriate joint of hinged milling with a double "S". The upholstery on the inside is realized through the use of expanded CFC free polyurethane foam cold formed in precise moulds, and then it is applied to a layer of Baydur 60 polyurethane cold formed inside of another mould. These are then bonded to the multi layer frame using polyurethane glue with a catalyst.

The inside of the seat is always upholstered in either leather or fabric. The outside, however, has different options, and can be ordered:

- Covered in leather or fabric with a light upholstery, utilizing a thin and consistent thickness of CFC free polyurethane
- Veneered in hardwood like lati or similar to ebony
- Lacquered in a matte finish white, black, or RAL 1019 color.

The seating consists of a firm CFC free polyurethane cushion, completely upholstered in leather or fabric.

The arm chairs are equipped with a swivel tilt and lift mechanism with gas hydraulic dampening, and the base is die cast in aluminum with a high polish on the upper portion, and black lacquered on the lower section.

There are also three different bases available:

- Chromed tubular base with four points
- Tubular base with a round chromed plate

Specific mount for counter or restaurant bar

POLTRONE / ARMCHAIRS



L/W 57 cm - A/H 121-130 cm - a/h 50-59 cm - P/D 61 cm
L/W 22"1/2 - A/H 47"5/8-51"1/4 cm - a/h 19"5/8-23"1/4 - P/D 24"

SILHOUPLT001 SILHOUPLT002 SILHOUPLT003



L/W 57 cm - A/H 98-107 cm - a/h 50-59 cm - P/D 61 cm
L/W 22"1/2 - A/H 38"1/2-42"1/8 cm - a/h 19"5/8-23"1/4 - P/D 24"

SILHOUPLT004 SILHOUPLT005 SILHOUPLT006



L/W 57 cm - A/H 88-97 cm - a/h 50-59 cm - P/D 57 cm
L/W 22"1/2 - A/H 34"5/8-38"1/4 cm - a/h 19"5/8-23"1/4 - P/D 22"1/2

SILHOUPLT007 SILHOUPLT008 SILHOUPLT009

SILHOUETTE

DESIGN: LUCA SCACCHETTI

POLTRONE / ARMCHAIRS



L/W 57 cm - A/H 120 cm - a/h 49 cm - P/D 61 cm
L/W 22"1/2 - A/H 47"1/4 cm - a/h 19"1/4 - P/D 24"

SILHOUPLT019 SILHOUPLT020 SILHOUPLT021



L/W 57 cm - A/H 97 cm - a/h 49 cm - P/D 61 cm
L/W 22"1/2 - A/H 38"1/4 cm - a/h 19"1/4 - P/D 24"

SILHOUPLT022 SILHOUPLT023 SILHOUPLT024



L/W 57 cm - A/H 87 cm - a/h 49 cm - P/D 57 cm
L/W 22"1/2 - A/H 34"1/4 cm - a/h 19"1/4 - P/D 22"1/2

SILHOUPLT025 SILHOUPLT026 SILHOUPLT027

SGABELLO / STOOL



L/W 57 cm - A/H 49 cm - P/D 50 cm
L/W 22"1/2 - A/H 19"1/4 cm - P/D 19"5/8

SILHOUPLT028 SILHOUPLT029 SILHOUPLT030

SEDIA / CHAIR



L/W 57 cm - A/H 85 cm - a/h 49 cm - P/D 57 cm
L/W 22"1/2 - A/H 33"1/2 cm - a/h 19"1/4 - P/D 22"1/2

SILHOUPLT031 SILHOUPLT032 SILHOUPLT033

SGABELLO BAR / BARSTOOL



L/W 57 cm - A/H 100-126 cm - a/h 62-88 cm - P/D 57 cm
L/W 22"1/2 - A/H 39"3/8-49"5/8 cm - a/h 24"3/8-34"5/8 cm - P/D 22"1/2

SILHOUPLT034 SILHOUPLT035 SILHOUPLT036

TUCROMA

DESIGN: GUIDO FALESCHINI

La sedia tucroma ha una struttura in tubolare d'acciaio cromato. Il cuscino di seduta ha una struttura in multistrato di faggio annegato in uno stampo di poliuretano schiumato a freddo; lo schienale invece è in poliuretano schiumato a freddo. I due cuscini sono collegati fra di loro tramite due larghe cinghie di cuoio.

The tucroma chair have a chromed tubular steel frame. The seat cushion has a frame in beech-wood multiply panel embedded in a cold formed polyurethane, whereas the back is in cold formed polyurethane. The two cushions are connected between each other through two wide saddle leather straps.

SEDIE / CHAIRS



L/W 53 cm - A/H 83 cm - P/D 51 cm
L/W 20" 7/8 - A/H 32" 2/3 - P/D 20" 1/8

TUCROMSEDIASB

WING

DESIGN: LUCA SCACCHETTI

Le poltrone direzionali, conferenza e le sedie hanno tutte un'unica struttura di sedile e schienale realizzata in multistrato di faggio curvato in stampo. I braccioli sono realizzati sempre in multistrato di faggio curvato in stampo ed inseriti ad incastro lungo lo spessore del corpo principale della struttura con una fresatura articolata a doppia S. Tutti i modelli hanno una leggera imbottitura in poliuretano espanso indeformabile ed esente da CFC sul lato interno dello schienale e del sedile (solo per le sedie su slitta) ed in seguito sono ricoperte completamente in cuoio. Il retro dello schienale può anch'esso essere imbottito e completamente rivestito in cuoio oppure impiallacciato in acero lucidato opaco a vista o in noce canaletto lucidato opaco a vista. Il sedile delle poltrone è dotato di un cuscinetto in poliuretano espanso indeformabile ed esente da CFC completamente rivestito in cuoio. Anche i braccioli ove previsti sono completamente rivestiti in cuoio. Esiste infine una versione della poltrona direzionale in cui la struttura è completamente impiallacciata sia nel lato interno che in quello esterno in acero lucidato opaco a vista ed è dotata solamente di un cuscinetto in poliuretano espanso indeformabile ed esente da CFC completamente rivestito in cuoio. Le poltrone sono girevoli, regolabili in altezza con elevazione a gas e sono dotate di meccanismo basculante; la base è a 5 razze in alluminio pressofuso verniciata a polveri epossidiche colore grigio alluminio oppure nero metallizzato raggrinzante. La sedia ha un basamento a slitta in tubolare d'acciaio verniciato a polveri epossidiche colore grigio alluminio oppure nero metallizzato raggrinzante; nella versione che li prevede i braccioli sono rivestiti in cuoio.

The executive and conference armchairs and the chairs all have a single seat and backrest structure made in die-bent beech multiply. The arms are always made in die-bent multiply and slotted into the thickness of the seat thanks to a groove with a double S shape. All the models are lightly padded in resilient CFC-free polyurethane foam, on the internal side of the armchair backrest and the seat (only for the chairs on slides) and then, they are completely covered by saddle leather. The rear of the backrest can be padded and completely covered by saddle leather or can be veneered with semi-polished maple wood or black walnut wood. The seat of the armchairs have a cushion in resilient CFC-free polyurethane foam and completely covered by saddle leather. The arms, when provided, are completely covered by saddle leather. There is also an executive armchair where the frame is completely veneered with semi-polished maple on the internal and external side. This chair has also a cushion in resilient CFC-free polyurethane foam and completely covered by saddle leather. The swivel armchairs are height adjustable with a gas piston and are fitted with a tilt mechanism; they also have a 5-star base in die-cast aluminium epoxy powder varnished with grey or wrinkled black colour. The tubular steel slide base of the chair is epoxy powder varnished with grey or wrinkled black colour. The arms, when provided, are covered in saddle leather.

POLTRONE / ARMCHAIRS



L/W 71 cm - A/H 121-130 cm - a/h 47-56 cm - P/D 69 cm
L/W 28" - A/H 47"5/8 - 51"1/4 cm - a/h 18"1/2 - 22" cm - P/D 27"1/8

WING00POLT001

WING00POLT012

WING00POLT017



L/W 71 cm - A/H 101-110 cm - a/h 47-56 cm - P/D 69 cm
L/W 28" - A/H 39"3/4 - 43"1/4 cm - a/h 18"1/2 - 22" cm - P/D 27"1/8

WING00POLT004

WING00POLT014

WING00POLT018



L/W 48 cm - A/H 101-110 cm - a/h 47-56 cm - P/D 69 cm
L/W 18"7/8 - A/H 39"3/4 - 43"1/4 cm - a/h 18"1/2 - 22" cm - P/D 27"1/8

WING00POLT003

WING00POLT013

WING00POLT019

office

▶ DIVANI E POLTRONE
SOFAS AND ARMCHAIRS

 **Mariani**

292	LOUNGE
293	SAVILE ROW
294	BLOB
295	WOODY
296	PIGRECO
297	QUEBEC
298	CHESTERMAN
299	KUBICO
300	NIKITA











BLOB DESIGN: UMBERTO ASNAGO

La poltrona è disponibile completamente rivestita in pelle o tessuto. La struttura della poltrona è costituita da due elementi distinti di schienale e sedile. Il sedile ha una struttura in tubolare d'acciaio al quale sono fissate cinghie elastiche in polipropilene con elasticità dell'80% opportunamente incrociate fra loro. Lo schienale ha una struttura in tubolare d'acciaio fissato ad un pannello di multistrato di pioppo. Le due strutture di sedile e schienale sono poi inserite in opportuni stampi e schiumate a freddo con poliuretano espanso; questo prodotto soddisfa la Classe 11M di resistenza al fuoco secondo la legge italiana ed è disponibile – su richiesta – anche secondo altri standard internazionali. Prima del rivestimento vengono applicate anche delle fibre poliestere. I 4 piedini sono in ABS nero. La poltrona è disponibile anche con basamento in acciaio girevole.

The armchair is available completely covered in leather or in fabric. The frame of the relax armchair is composed by two pieces one for the back and one for the seat. The frame of the seat is in tubular steel with elastic polypropylene and natural latex belts with 80% elasticity fixed to the frame in a cross way. The frame of the back is in tubular steel fixed to a panel of poplar plywood. Both these frames are embedded in a polyurethane cold formed in mould and the item comply to the Italian Classe 11M fire resistant laws and is also available on request for other international standards. Before upholstering, a sheet of polyester wadding is glued to the polyurethane. The 4 legs are in black ABS. The armchair is available also with metal swivel base.

POLTRONA / ARMCHAIR



L/W 75 cm - A/H 71 cm - P/D 80 cm
L/W 29"1/2 - A/H 28" - P/D 31"1/2

BLOB00POLTRON

CHESTERMAN DESIGN: AMMANNATI & VITELLI

La struttura è in legno massello di pioppo con alcuni elementi di collegamento in pannello nobilitato; il molleggio è realizzato tramite delle cinghie elastiche in polipropilene e lattice naturale. L'imbottitura della struttura e dei cuscini fissi della seduta è in poliuretano espanso a densità differenziata e ovatta poliestere. I supporti sono in acciaio cromato. Rivestimenti disponibili in tessuto o pelle entrambi non sfoderabili.

The frame is in solid poplar wood with some connection elements in melamine coated panels; the springing is due to elastic belts in polypropylene and natural latex. The padding of the frame and of the fixed cushions is made in polyurethan foam with different density and polyester wadding. The feet are in chromed steel. The cover is available in fabric or leather, both undressable.

POLTRONA / ARMCHAIR



L/W 82 cm - A/H 79 cm - a/h 44 cm - P/D 76 cm
L/W 32"1/4 - A/H 31"1/8 cm - a/h 17"3/8 - P/D 29"7/8

CHESTEPOLTRON

DIVANI / SOFAS



L/W 150 cm - A/H 79 cm - a/h 44 cm - P/D 76 cm
L/W 59" - A/H 31"1/8 cm - a/h 17"3/8 - P/D 29"7/8

CHESTEDIVA2PO



L/W 198 cm - A/H 79 cm - a/h 44 cm - P/D 76 cm
L/W 78" - A/H 31"1/8 cm - a/h 17"3/8 - P/D 29"7/8

CHESTEDIVA3PO

KUBICO DESIGN: MAURO LIPPARINI

La struttura portante è realizzata in legno massello di pioppo e di olmo con alcuni elementi di collegamento in legno compensato di pioppo; il legno è stagionato "naturalmente" per almeno tre anni in cataste custodite presso l'azienda. Le giunzioni dei vari elementi della struttura sono costruite mediante unioni ad incastro con spine cilindriche. Il molleggio della seduta è composto da cinghie elastiche in polipropilene e lattice naturale di due dimensioni ed elasticità. Perpendicolarmente alla lunghezza del modello sono fissate cinghie da 9 cm, con elasticità del 20%, una parallela all'altra; a queste sono alternatamente incrociate cinghie da 5 cm con elasticità dell'80%. L'imbottitura della struttura è ottenuta con lastre in poliuretano espanso indeformabile (con densità di 75 kg/m³) ed esente da CFC ed in seguito ricoperta con ovatta poliestere e vellutino accoppiato. I cuscini asportabili della seduta e dello schienale sono in waterlily™ (con densità di 45 kg/m³) ed in seguito ricoperti con ovatta poliestere e vellutino accoppiato; inoltre i cuscini dello schienale hanno al loro interno un inserto di esoflex, un materiale che consente flessibilità solo per la lunghezza del cuscino ma non per l'altezza. In questo modo il cuscino mantiene la dovuta portanza anche con uno schienale basso. I supporti sono prodotti in tubolare quadro d'acciaio con tre possibili finiture: verniciatura in 8 colori a polveri epossidiche, cromatura o bronzatura. I tavolini in diverse forme e dimensioni sono disponibili con piano in pannello nobilitato rivestito in cuoio, in cristallo fumé, in marmo Calacatta Oro, in marmo nero Marquina in marmo Bianco venato Gioia e in acciaio lucido.

Waterlily™ è un poliuretano espanso veramente innovativo con caratteristiche di assoluto rilievo: **Il rispetto ambientale** – è stato il primo poliuretano con espansione a base d'acqua e/o anidride carbonica, senza impiego di CFC o sostanze alogenate o altre sostanze nocive. Inoltre è stato progettato per essere riciclato meccanicamente e chimicamente al 100%. **Salute** – la sua struttura cellulare aperta consente una elevata traspirabilità e garantisce il libero passaggio di aria e la veloce dispersione di calore ed umidità, evitando così la proliferazione di acari e l'insorgere di allergie. **Comfort** – morbido in superficie ma in grado di sostenere adeguatamente il peso, si adatta perfettamente alla forma del corpo e distribuisce il peso in modo equilibrato dando una elevata sensazione di comfort. **Durata** – grazie alla sua omogeneità intrinseca, i test effettuati hanno dimostrato che le caratteristiche di resistenza all'invecchiamento a umido, di deformazione permanente e di fatica dinamica, sono le migliori della sua categoria; questo assicura una maggiore durata nel tempo di elasticità e forma.

The load-bearing frame is constructed of poplar heartwood and elm with additional connecting elements in poplar plywood. Dap joints unite the various parts of the frame with securing cylindrical dowels. The carefully selected wood is naturally seasoned for at least three years on the company's premises. The seat webbing consists of elastic polypropylene and natural latex belts in two sizes, each with its own precisely defined elasticity. Belts 9 cm wide are fixed parallel to each other and perpendicularly to the length of Kubico at 20% elasticity; these are interlaced by 5 cm wide belts at 80% elasticity. The framework is upholstered with contoured sheets of resilient, CFC-free polyurethane foam (density 75 kg/m³), covered with bonded plush and polyester wadding. The removable seat and back cushions, fabricated from high-quality waterlily™ (density 45 kg/m³), are likewise sheathed in bonded plush and polyester wadding. Rear cushion flexibility is controlled by esoflex inserts, ensuring proper lower back support. The square, tubular steel supports are available in three different finishes: varnished in eight colors with epoxy powder paint, chromed, or bronzed.

The coffee tables in various shapes and dimensions are available with top in melamine coated panel covered with saddle leather, in smoked tempered glass, in Calacatta Oro marble, in black Marquina marble, in white-veined Gioia marble and in polished steel.

Waterlily™ is a polyurethane foam really innovative with some technical characteristics absolutely important: **The respect of the ambient** – it is the first polyurethane using water and/or carbonic anhydride as expander without using CFC and halogenated or other toxic substances. **Moreover it has been studied in order to be mechanically and chemically recycled at 100%.** **Health** – its opened cellular structure allows an high transpirability and enable air to freely circulate inside the foam; the warmth and the humidity absorbed during the contact with the human body are quickly dispelled avoiding the acarus proliferation and the allergies rising. **Comfort** – soft in its surface but at the same time able to sustain the weight adequately, it adapts itself perfectly to the body and distributes the weight in the most balanced way, giving an high sensation of comfort. **Duration** – thanks to its own homogeneous structure, the tests made have shown that the characteristics of humid ageing resistance, of permanent deformation and the dynamic fatigue limit are the best in its category; this ensure a longer duration in time of elasticity and shape.

POLTRONE / ARMCHAIRS



L/W 112 cm
L/W 44"1/8

KUBICOPOLT112



L/W 128 cm - A/H 76 cm - P/D 100 cm
L/W 50"2/5 - A/H 29"7/8 - P/D 39"3/8

KUBICOPOLT128

POLTRONE GIREVOLI / SWIVEL ARMCHAIRS



L/W 112 cm
L/W 44"1/8

KUBICOPOGI112



L/W 128 cm - A/H 76 cm - P/D 100 cm
L/W 50"2/5 - A/H 29"7/8 - P/D 39"3/8

KUBICOPOGI128

DIVANI / SOFAS



L/W 180 cm
L/W 70"7/8

KUBICODIVA180



L/W 210 cm
L/W 82"2/3

KUBICODIVA210



L/W 240 cm
L/W 94"1/2

KUBICODIVA240



L/W 270 cm - A/H 76 cm - P/D 100 cm
L/W 106"2/7 - A/H 29"7/8 - P/D 39"3/8

KUBICODIVA270

POUF / OTTOMANS



L/W 42 cm - A/H 38 cm - P/D 42 cm
L/W 16"1/2 - A/H 15" - P/D 16"1/2

KUBICOPOU4040



L/W 100 cm - A/H 36 cm - P/D 100 cm
L/W 39"3/8 - A/H 14"1/6 - P/D 39"3/8

KUBICOPOUQ100



L/W 100 cm - A/H 36 cm - P/D 100 cm
L/W 39"3/8 - A/H 14"1/6 - P/D 39"3/8

KUBICOPOUTOND



L/W 100 cm - A/H 20 cm - P/D 100 cm
L/W 39"3/8 - A/H 7"7/8 - P/D 39"3/8



KUBICOPOUTOSP





L/W 100 cm - A/H 20 cm - P/D 100 cm
L/W 39"3/8 - A/H 7"7/8 - P/D 39"3/8

KUBICOPOUQU5P



TAVOLINI CRISTALLO / CRYSTAL LOW TABLES

		
L/W 40 cm - A/H 50 cm - P/D 40 cm L/W 15"3/4 - A/H 19"5/7 - P/D 15"3/4	L/W 100 cm - A/H 27 cm - P/D 100 cm L/W 39"3/8 - A/H 10"5/8 - P/D 39"3/8	L/W 150 cm - A/H 27 cm - P/D 70 cm L/W 59" - A/H 10"5/8 - P/D 27"4/7
KUBICOTASERCR	KUBICOTAVQUCR	KUBICOTAVRECR





TAVOLINI CUOIO / LEATHER LOW TABLES

		
L/W 40 cm - A/H 50 cm - P/D 40 cm L/W 15"3/4 - A/H 19"5/7 - P/D 15"3/4	L/W 100 cm - A/H 27 cm - P/D 100 cm L/W 39"3/8 - A/H 10"5/8 - P/D 39"3/8	L/W 150 cm - A/H 27 cm - P/D 70 cm L/W 59" - A/H 10"5/8 - P/D 27"4/7
KUBICOTASERCU	KUBICOTAVQUCU	KUBICOTAVRECU





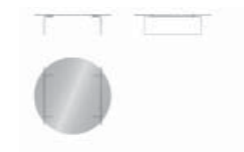

TAVOLINI MARMO / MARBLE LOW TABLES

		
L/W 40 cm - A/H 50 cm - P/D 40 cm L/W 15"3/4 - A/H 19"5/7 - P/D 15"3/4	L/W 100 cm - A/H 27 cm - P/D 100 cm L/W 39"3/8 - A/H 10"5/8 - P/D 39"3/8	L/W 150 cm - A/H 27 cm - P/D 70 cm L/W 59" - A/H 10"5/8 - P/D 27"4/7
KUBICOTASERMC KUBICOTASERMM	KUBICOTAVQUMC KUBICOTAVQUMM	KUBICOTAVREMC KUBICOTAVREMM







TAVOLINI CRISTALLO / CRYSTAL LOW TABLES

					
Ø 40 cm - A/H 45 cm Ø 15"3/4 - A/H 17"5/7	Ø 40 cm - A/H 17 cm Ø 15"3/4 - A/H 6"5/7	Ø 60 cm - A/H 23 cm Ø 23"5/8 - A/H 9"	Ø 100 cm - A/H 27 cm Ø 39"3/8 - A/H 10"5/8	Ø 120 cm - A/H 27 cm Ø 47"1/4 - A/H 10"5/8	Ø 150 cm - A/H 27 cm Ø 59" - A/H 10"5/8
KUBICOTAA40CR	KUBICOTA040CR	KUBICOTA060CR	KUBICOTA100CR	KUBICOTA120CR	KUBICOTA150CR

TAVOLINI CUOIO / LEATHER LOW TABLES

					
Ø 40 cm - A/H 45 cm Ø 15"3/4 - A/H 17"5/7	Ø 40 cm - A/H 17 cm Ø 15"3/4 - A/H 6"5/7	Ø 60 cm - A/H 23 cm Ø 23"5/8 - A/H 9"	Ø 100 cm - A/H 27 cm Ø 39"3/8 - A/H 10"5/8	Ø 120 cm - A/H 27 cm Ø 47"1/4 - A/H 10"5/8	Ø 150 cm - A/H 27 cm Ø 59" - A/H 10"5/8
KUBICOTAA40CU	KUBICOTA040CU	KUBICOTA060CU	KUBICOTA100CU	KUBICOTA120CU	KUBICOTA150CU

TAVOLINI MARMO / MARBLE LOW TABLES

					
Ø 40 cm - A/H 45 cm Ø 15"3/4 - A/H 17"5/7	Ø 40 cm - A/H 17 cm Ø 15"3/4 - A/H 6"5/7	Ø 60 cm - A/H 23 cm Ø 23"5/8 - A/H 9"	Ø 100 cm - A/H 27 cm Ø 39"3/8 - A/H 10"5/8	Ø 120 cm - A/H 27 cm Ø 47"1/4 - A/H 10"5/8	Ø 150 cm - A/H 27 cm Ø 59" - A/H 10"5/8
KUBICOTAA40MC KUBICOTAA40MM	KUBICOTA040MC KUBICOTA040MM	KUBICOTA060MC KUBICOTA060MM	KUBICOTA100MC KUBICOTA100MM	KUBICOTA120MC KUBICOTA120MM	KUBICOTA150MC KUBICOTA150MM

Il modello è disponibile rivestito in pelle o tessuto (non sfoderabile) o di entrambe. Il piede è verniciato color titanio.
La struttura portante è realizzata in legno massello di pioppo stagionato naturalmente, con alcuni elementi di collegamento in legno compensato di pioppo; le giunzioni dei vari elementi della struttura sono costruite mediante unioni ad incastro con spine cilindriche. Lo schienale è costituito da multistrato di faggio curvato in stampo. Il molleggio della seduta è composto da cinghie elastiche in polipropilene e lattice naturale di due dimensioni ed elasticità. L'imbottitura della struttura è ottenuta con lastre in poliuretano espanso indeformabile a densità differenziate (tra 30 e 35 kg/m3) ed esente da CFC ed in seguito ricoperta con ovatta poliesteri e vellutino accoppiato.

The model is available upholstered in leather or fabric (the cover is not always with a non-removable cover) or both. The foot is titanium colored.
The supporting structure is made of naturally seasoned poplar solid wood, with some connecting elements in poplar plywood; the junctions of the various elements of the structure are built using interlocking joints with cylindrical spines. The back is made of molded bent beech plywood. The seat suspension is composed of elastic straps in polypropylene and natural latex of two sizes and elasticity. The padding of the structure is obtained with non-deformable polyurethane foam slabs with different densities (between 30 and 35 kg/m3) and CFC-free and then covered with polyester wadding and coupled velvet.

POLTRONA / ARMCHAIR



L/W 86 cm - A/H 75 cm - a/h 43 cm - P/D 78 cm
L/W 33"7/8 - A/H 29"1/2 - a/h 16"7/8 - P/D 30"3/4

LOUNGEPOLTO86

DIVANI / SOFAS



L/W 143 cm - A/H 75 cm - a/h 43 cm - P/D 78 cm
L/W 56"1/4 - A/H 29"1/2 - a/h 16"7/8 - P/D 30"3/4

LOUNGEDIVA143

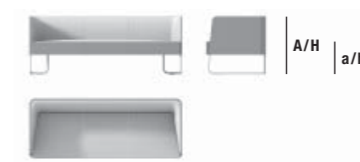

L/W 199 cm - A/H 75 cm - a/h 43 cm - P/D 78 cm
L/W 78"3/8 - A/H 29"1/2 - a/h 16"7/8 - P/D 30"3/4

LOUNGEDIVA200

La struttura è in legno massello di pioppo con alcuni elementi di collegamento in pannello nobilitato; il molleggio è realizzato tramite delle cinghie elastiche in polipropilene e lattice naturale. L'imbottitura della struttura e dei cuscini fissi della seduta è in poliuretano espanso a densità differenziata e ovatta poliesteri. I supporti sono in legno massello di pioppo completamente rivestiti in cuoio. Rivestimenti disponibili in tessuto o pelle entrambi non sfoderabili.

The frame is in solid poplar wood with some connection elements in melamine coated panel; the springing is granted by some elastic belts in polypropylene and natural latex. The padding of the frame and the fixed cushions of the seat are made by polyurethane foam with different densities and polyester wadding. The solid poplar wood supports are completely covered by saddle leather. Coverings available in fabric or leather, both not removable.

POLTRONA / ARMCHAIR



L/W 82 cm - A/H 78 cm - a/h 42 cm - P/D 79 cm
L/W 32"1/4 - A/H 30"3/4" - a/h 16"1/2 - P/D 31"1/8

NIKITAPOLTRON

POUF / OTTOMAN



L/W 57 cm - A/H 42 cm - P/D 57 cm
L/W 22"1/2 - A/H 16"1/2 - P/D 22"1/2

NIKITAPOUF000

DIVANI / SOFAS



L/W 160 cm - A/H 78 cm - a/h 42 cm - P/D 79 cm
L/W 63" - A/H 30"3/4" - a/h 16"1/2 - P/D 31"1/8

NIKITADIVA2PO



L/W 194 cm - A/H 78 cm - a/h 42 cm - P/D 79 cm
L/W 76"3/8 - A/H 30"3/4" - a/h 16"1/2 - P/D 31"1/8

NIKITADIVA3PO

Una serie di sedute, poltroncine e divani che appaiono come volanti e sospese. Sedute lineari o che rigirano ad angolo, che seguono l'andamento dei muri o che disegnano liberamente linee spezzate. L'appoggio metallico a terra a forma di π (Pigreco) distaccato dalla seduta vera e propria rende questo sistema estremamente leggero, straniante, inaspettato pur nel mantenimento di una forte immagine rappresentativa sottolineata dalla straordinarietà dei materiali, pelli e cuoio. La struttura della piattaforma è costituita da due telai in legno massello di pioppo accoppiati l'uno all'altro. Su quello inferiore, esternamente rivestito in cuoio, vengono fissate delle cinghie elastiche in polipropilene e lattice naturale da 5 cm di larghezza ed elasticità dell'80% alternatamente incrociate fra di loro a 90°; così viene garantito il molleggio della seduta. Sul telaio superiore viene incollata una lastra di poliuretano espanso indeformabile con densità di 35 kg/m3 ed esente da CFC; questo viene poi rivestito con la trapunta di ovatta poliesteri e tessuto o pelle. La struttura dello schienale e del bracciolo, è realizzata in pannello nobilitato nero imbottito con lastre di poliuretano espanso indeformabile con densità di 40 kg/m3 ed esente da CFC ed in seguito ricoperta con ovatta poliesteri. Su questa struttura sono fissate delle barre d'acciaio che consentono l'aggancio dello schienale al telaio inferiore della piattaforma. I cuscini asportabili dello schienale sono realizzati completamente poliuretano espanso. Il basamento è realizzato da un tubolare d'acciaio cromato.

Series designed by Luca Scacchetti comprises seating, armchairs, and sofas that appear to be flying, or suspended. It can remain linear, or turn corners to follow the walls, and can include segments. The metallic supports - shaped as the ancient greek letter π - are separated from the seating to maintain this strong, yet extremely light, representative image, underlined by the exceptional leather and saddle leather materials. The frame of the platform consists of two poplar haertwood panels fixed together. On the lower panel, covered externally with saddle leather, are fixed elastic polypropylene and natural latex belts of 5 cm wide at 80% elasticity, interlaced together at 90°; in this way the seat webbing is guaranteed. On the upper panel is glued a sheet of resilient, CFC-free polyurethane foam (density 35 kg/m3) covered with polyester wadding and fabric or leather. The frame of the back and of the arm, is made of black melamine coated panel upholstered with contoured sheets of resilient, CFC-free polyurethane foam (density 40kg/m3) covered with polyester wadding. On this frame are fixed steel bars used to hook the back to the lower panel of the platform. The removable back cushions are completely in polyurethane foam. The base support is made in tubular chromed steel.

POLTRONA / ARMCHAIR

A/H a/h	A/H a/h	A/H a/h
L/W 91 cm - A/H 74 cm - a/h 42 cm - P/D 91 cm L/W 35"3/4 - A/H 29 1/8" - a/h 16"1/2 - P/D 35"3/4	L/W 91 cm - A/H 74 cm - a/h 42 cm - P/D 91 cm L/W 35"3/4 - A/H 29 1/8" - a/h 16"1/2 - P/D 35"3/4	L/W 91 cm - A/H 74 cm - a/h 42 cm - P/D 91 cm L/W 35"3/4 - A/H 29 1/8" - a/h 16"1/2 - P/D 35"3/4
PIGRECPOLTRON	PIGRECPOLTRDX	PIGRECPOLTRSX

DIVANI / SOFAS

A/H a/h	A/H a/h	A/H a/h
L/W 152 cm - A/H 74 cm - a/h 42 cm - P/D 91 cm L/W 59"7/8 - A/H 29 1/8" - a/h 16"1/2 - P/D 35"3/4	L/W 152 cm - A/H 74 cm - a/h 42 cm - P/D 91 cm L/W 59"7/8 - A/H 29 1/8" - a/h 16"1/2 - P/D 35"3/4	L/W 152 cm - A/H 74 cm - a/h 42 cm - P/D 91 cm L/W 59"7/8 - A/H 29 1/8" - a/h 16"1/2 - P/D 35"3/4
PIGRECDIVA2PO	PIGRECDIVA2DX	PIGRECDIVA2SX

A/H a/h	A/H a/h	A/H a/h
L/W 213 cm - A/H 74 cm - a/h 42 cm - P/D 91 cm L/W 83"7/8 - A/H 29 1/8" - a/h 16"1/2 - P/D 35"3/4	L/W 213 cm - A/H 74 cm - a/h 42 cm - P/D 91 cm L/W 83"7/8 - A/H 29 1/8" - a/h 16"1/2 - P/D 35"3/4	L/W 213 cm - A/H 74 cm - a/h 42 cm - P/D 91 cm L/W 83"7/8 - A/H 29 1/8" - a/h 16"1/2 - P/D 35"3/4
PIGRECDIVA3PO	PIGRECDIVA3DX	PIGRECDIVA3SX

PANCHE / BENCHS

L/W 91 cm - A/H 42 cm - P/D 91 cm L/W 35"3/4 - A/H 16"1/2 - P/D 35"3/4	L/W 152 cm - A/H 42 cm - P/D 91 cm L/W 59"7/8 - A/H 16"1/2 - P/D 35"3/4	L/W 213 cm - A/H 42 cm - P/D 91 cm L/W 83"7/8 - A/H 16"1/2 - P/D 35"3/4
PIGRECPANCA1P	PIGRECPANCA1P	PIGRECPANCA1P

CUSCINI / CUSHIONS

L/W 60 cm - A/H 35 cm - P/D 13/22 cm L/W 23"5/8 - A/H 13"3/4 - P/D 5"1/8/8"5/8	L/W 74 cm - A/H 35 cm - P/D 13/22 cm L/W 29"1/8 - A/H 13"3/4 - P/D 5"1/8/8"5/8
PIGRECSCHRETT	PIGRECSCHRETE

TAVOLINI / COFFEE TABLES

L/W 140 cm - A/H 26 cm - P/D 70 cm L/W 55"1/8 - A/H 10"1/4 - P/D 27"1/2	L/W 90 cm - A/H 26 cm - P/D 90 cm L/W 35"1/2 - A/H 10"1/4 - P/D 35"1/2	L/W 50 cm - A/H 26 cm - P/D 90 cm L/W 19"5/8 - A/H 10"1/4 - P/D 35"1/2
PIGRECTAVOLIN	PIGRECTAVANGO	PIGRECTAVTERM

La struttura è in legno massello di pioppo con alcuni elementi di collegamento in pannello nobilitato; il molleggio è realizzato tramite delle cinghie elastiche in polipropilene e lattice naturale. L'imbottitura della struttura e dei cuscini asportabili della seduta è in poliuretano espanso a densità differenziate e ovatta poliesteri; i cuscini dello schienale invece sono in piuma a camere separate. I supporti sono in PVC nero.

The frame is in solid poplar wood with some connection elements in melamine coated panel; the springing is granted by some elastic belts in polypropylene and natural latex. The padding of the frame and of the removable seat cushions are made by polyurethane foam with different densities and polyester wadding, while the back cushions are feather-filled in separate units. The supports are in black PVC.

POLTRONA / ARMCHAIR

A/H a/h	A/H a/h	A/H a/h
L/W 78 cm - A/H 84 cm - a/h 48 cm - P/D 78 cm L/W 30"3/4 - A/H 33"1/8 - a/h 18"7/8 - P/D 30"3/4	L/W 138 cm - A/H 84 cm - a/h 48 cm - P/D 78 cm L/W 54"3/8 - A/H 33"1/8 - a/h 18"7/8 - P/D 30"3/4	L/W 198 cm - A/H 84 cm - a/h 48 cm - P/D 78 cm L/W 78" - A/H 33"1/8 - a/h 18"7/8 - P/D 30"3/4
QUEBECPOLTRON	QUEBECDIVA2PO	QUEBECDIVA3PO

SAVILE ROW DESIGN: ALESSANDRO DUBINI

Il modello è disponibile rivestito completamente in pelle o tessuto oppure parte esterna in cuoio o pelle e parte interna in tessuto. Il basamento è in massello di noce canaletto con finitura a cera.

La struttura è realizzata in multistrato di pioppo curvato in stampo mentre l'imbottitura è realizzata con poliuretano espanso con densità differenziate fra 25 e 30 Kg/m³, rivestito con ovatta poliestere.

I tavolini hanno il piano superiore ed inferiore (optional) in cristallo extralight oppure rivestito in cuoio o pelle. Basamento in massello di noce canaletto con finitura a cera.

The model is available completely covered in leather or fabric, or with the external side in saddle leather or leather and the internal side in fabric. The base is in solid black walnut wood with matt finishing "wax effect".

The frame is in beech plywood panel curved into a mould, while the padding is made with contoured sheets of resilient, CFC-free polyurethane foam with different density between 25 and 30 kg/m³ and covered with polyester wadding.

The low tables have the upper and lower top available in extralight glass or covered in saddle leather or leather. The base is in solid black walnut wood with matt finishing "wax effect".

POLTRONA / ARMCHAIR



L/W 84 cm - A/H 74 cm - a/h 39 cm - P/D 75 cm
L/W 33"1/8 - A/H 29"1/8 - a/h 15"3/8 - P/D 29"1/2

SAVILECSP0084
SAVILECFP0084
SAVILECVPO084

DIVANO / SOFA



L/W 163 cm - A/H 74 cm - a/h 39 cm - P/D 75 cm
L/W 64"1/8 - A/H 29"1/8 - a/h 15"3/8 - P/D 29"1/2

SAVILECSD1163
SAVILECFD1163
SAVILECVD1163

TAVOLINI / LOW TABLES



L/W 150 cm - A/H 37 cm - P/D 75 cm
L/W 59" - A/H 14"5/8 - P/D 29"1/2

SAVILETA152CR



L/W 150 cm - A/H 37 cm - P/D 75 cm
L/W 59" - A/H 14"5/8 - P/D 29"1/2

SAVILETA152CU



L/W 75 cm - A/H 37 cm - P/D 75 cm
L/W 29"1/2 - A/H 14"5/8 - P/D 29"1/2

SAVILETA075CR



L/W 75 cm - A/H 37 cm - P/D 75 cm
L/W 29 1/2" - A/H 14 5/8" - P/D 29 1/2"

SAVILETA075CU

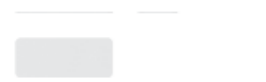

L/W 126,5 cm - A/H 1 cm - P/D 51,5 cm
L/W 49"3/4 - A/H 3/8" - P/D 20"1/4

SAVILERA128CR



L/W 126,5 cm - A/H 1 cm - P/D 51,5 cm
L/W 49"3/4 - A/H 3/8" - P/D 20"1/4

SAVILERA128CU



L/W 51,5 cm - A/H 1 cm - P/D 51,5 cm
L/W 20"1/4 - A/H 3/8" - P/D 20"1/4

SAVILERA052CR



L/W 51,5 cm - A/H 1 cm - P/D 51,5 cm
L/W 20 1/4" - A/H 3/8" - P/D 20 1/4"

SAVILERA052CU

WOODY DESIGN: UMBERTO ASNAGO

La poltrona è disponibile completamente rivestita in pelle o tessuto con basamento in noce canaletto finitura opaca a cera.

La struttura della poltrona è realizzata in legno massello di pioppo al quale sono fissate cinghie elastiche in polipropilene con elasticità dell'80%; l'imbottitura è realizzata con poliuretano espanso con densità differenziate fra 25 e 30 Kg/m³, rivestito con ovatta poliestere.

The armchair is available completely covered in leather or in fabric with the base in solid black walnut wood with matt finishing "wax effect".

The frame of the seat is in solid polar wood with elastic polypropylene and natural latex belts with 80% elasticity fixed to the frame. The armchair is upholstered with contoured sheets of resilient, CFC-free polyurethane foam with different density between 25 and 30 kg/m³ and covered with polyester wadding.

POLTRONA / ARMCHAIR



L/W 69 cm - A/H 78 cm - a/h 41 cm - P/D 80 cm
L/W 27"1/8 - A/H 30"3/4 - a/h 16"1/8 - P/D 31"1/2

WOODY0POLTRON

DIVANO / SOFA



L/W 130 cm - A/H 78 cm - a/h 41 cm - P/D 80 cm
L/W 51"1/4 - A/H 30"3/4 - a/h 16"1/8 - P/D 31"1/2

WOODY0DIVANET

Executive producer and set design: Studio Methodus, Giussano (MB)

Photographer: Master fotografie

Art buying and styling: Alessandra Salaris

Prepress: CD cromo

Printing: A.G. Bellavite

Tanks to:

C&C Milano, De Vecchi Milano 1935, Flos, Golran,
Kristiina Lassus Studio, Luceplan, Mascagni, Pallucco,
Penta Light, Prandina, Schiavon, Zava Luce.

Alberto Checa Ruiz

Alfredo Rapetti Mogol - Courtesy Boesso Art Gallery
Giordano Redaelli - Courtesy Boesso Art Gallery